

SPIS TREŚCI / TABLE OF CONTENTS

PAPIERY / PAPERS	04	KALENDARZE BIURKOWE / DESK CALENDARS	70
PAPIER Z LNU / LINEN PAPER ^{NEW}	05	OPAKOWANIA / PACKAGING	74
3D PRINT ^{NEW}	08	DODATKI / ADD-ONS	76
BLOKI AUTORSKIE / CUSTOMISED BLOCKS ^{NEW}	12	ŁĄCZENIE OPRAW / COVER COMBINATIONS	85
BLOKI AUTORSKIE NA RINGACH / CUSTOMISED BLOCKS WITH RINGS ^{NEW}	16	FLEXI	86
PAPIER Z NASIONAMI / PAPER WITH SEEDS	18	TYPY OPRAW / TYPES OF COVER	88
POSADŹ Z NAMI DRZEWO / PLANT A TREE WITH US	20	PROJEKT AUTORSKI / CUSTOMISED DESIGN	89
METODY ZNAKOWANIA / MARKING METHODS	22	PROPOZYCJE ROKÓW / YEAR DESIGN PROPOSITIONS	90
ZNAKOWANIE OPRAW / COVER MARKING	23	MATRYCE / STAMPS	94
SENSO	24	UKŁADY KALENDARZY DZIENNYCH / DAILY CALENDAR LAYOUTS	98
LAVA	28	UKŁADY KALENDARZY TYGODNIOWYCH / WEEKLY CALENDAR LAYOUTS	104
LINO	30	UKŁAD PLANERA / PLANNER LAYOUT	112
rPET	34	UKŁAD KALENDARZA DWUDZIENNEGO / TWO-DAY CALENDAR LAYOUT	114
RE-COVER	36	UKŁADY KALENDARZY BIURKOWYCH / DESK CALENDAR LAYOUTS	116
QUERK	38	UKŁADY NOTESOWE / NOTEBOOK LAYOUTS	118
SZYCIE KREATYWNE / CREATIVE STITCHING	40	GADŻETY / GADGETS	120
NATURA	42	SMYCZ WIELOFUNKCYJNA / MULTIFUNCTIONAL LANYARD	121
GAMBO	44	GADŻETY EKO / ECO GADGETS	122
CROSS	46	ROZGAŁĘŻNIKI USB / USB CHARGING CABLES	126
PIKO	47	OPAKOWANIA NA ROZGAŁĘŻNIKI / PACKAGING FOR CHARGING CABLES	128
GUMA	48	POWERBANKI / POWERBANKS	130
VIVELA	50	POWER SET	132
TŁOCZENIA / DEBOSSING	54	POWER SET LONG	133
CANVAS	56	ENERGY SET	134
CANVAS LINE	58	WHITE BOX & BLACK BOX	135
CANVAS PRINT ^{NEW}	60	ZESTAWIENIE BLOKÓW / OVERVIEW OF INTERIOR BLOCKS	136
KRAFT	62		
IMAGE	63		
IDEO	64		
IDEO EXCLUSIVE	66		
CARBON	68		



PAPIER Z TRAWY / GRASS PAPER



PAPIER Z CZYSTEJ CELULOZY Z DODATKIEM WŁÓKIEK Z TRAWY. PRODUKOWANY BEZ UŻYCIA WYBIELACZY OPTYCZNYCH, W 100% BIODEGRADOWALNY. JEDEN Z NAJLEPSZYCH BIO PAPIERÓW W EUROPIE.

PAPER MADE OUT OF PURE CELLULOSE WITH ADDITION OF GRASS FIBERS. PRODUCED WITHOUT ANY OPTICAL BRIGHTENERS, 100% BIODEGRADABLE. ONE OF THE BEST BIO PAPERS IN EUROPE.



PAPIER Z KAMIENIA / STONE PAPER

W 75% SKŁADA SIĘ Z WĘGLANU WAPNIA, DO JEGO PRODUKCJI NIE WYKORZYSTUJE SIĘ DREWNA, CELULOZY ANI WODY. JEST ODPORNY NA ZALANIA I ROZDARCIA. ULEGA FOTODEGRADACJI. PRODUKCJA 1 TONY PAPIERU Z KAMIENIA OSZCZĘDZA 17 DRZEW I 34 LITRY WODY ORAZ 477 KW ENERGII W PORÓWNIANIU Z PRODUKCJĄ PAPIERU TRADYCYJNEGO.

CONSISTS OF 75% CALCIUM CARBONATE, THERE IS NO WOOD, CELLULOSE OR WATER USED IN PRODUCTION. RESISTANT TO FLOODING AND TEARING. NOT RESISTANT TO PHOTODEGRADING. PRODUCING A TON OF STONE PAPER SAVES 17 TREES AND 34 LITERS OF WATER AS WELL AS 477 KW OF ENERGY COMPARED TO PRODUCING TRADITIONAL PAPER.



PAPIER Z RECYKLINGU / RECYCLED PAPER



WYKONANY W 100% Z ODZYSKANEGO, WTÓRNI PRZETWORZONEGO PAPIERU. WYPRODUKOWANY BEZ DODATKU OPTYCZNYCH ROZJAŚNIACZY I WYBIELAJĄCEGO CHLORU, WYSOKI POZIOM BIELI ZAWDZIĘCZA SPECJALNEMU PROCESOWI PRZETWARZANIA ODZYSKANEGO SUROWCA. PAPIER TEN CHARAKTERYZUJE SIĘ WYSOKĄ NIEPRZEZROCZYSTOŚCIĄ ORAZ WYSOKĄ ODPORNOŚCIĄ NA STARZENIE.

PRODUCED OF 100% RECOVERED FIBRE. MANUFACTURED WITHOUT OPTICAL BRIGHTENING AGENTS AND CHLORINE BLEACHING, HIGH WHITENESS THANKS TO A SPECIAL CONVERTING PROCESS FOR RECOVERED FIBRE. PRODUCT EXHIBITS HIGH OPACITY AND GOOD SHEET FORMATION AS WELL AS MAXIMUM AGEING RESISTANCE.



PAPIER Z NASIONAMI / PAPER WITH SEEDS

ROSĄCY PAPIER PRODUKOWANY JEST Z PAPIERU BIODEGRADOWALNEGO POPRZEZ UMIESZCZENIE W NIM NASION KWIATÓW POLNYCH: STOKROTKI, NIEZAPOMINAJKI, MAKU POLNEGO I FIRLETKI, CO NADAJE MU NATURALNĄ STRUKTURĘ. W 100% BIODEGRADOWALNY. JEST ZRÓWNOWAŻONYM, EKOLOGICZNYM I PRZYJAZNYM DLA ŚRODOWISKA RODZAJEM PAPIERU.

THE GROWING PAPER IS MADE OF BIODEGRADABLE PAPER BY PLACING IN IT SEEDS OF WILDFLOWERS: DAISIES, FENNEL, FIELD POPPIES AND FIRLETS, WHICH GIVES IT A NATURAL STRUCTURE. 100% BIODEGRADABLE. IT IS A SUSTAINABLE, ECOLOGICAL AND ENVIRONMENTALLY FRIENDLY TYPE OF PAPER.

WZORY PAPIERÓW EKOLOGICZNYCH PREZENTUJEMY NA KOŃCU KATALOGU I NA STRONIE 19. /
SAMPLES OF ECOLOGICAL PAPERS ARE PRESENTED AT THE END OF THE CATALOGUE AND ON PAGE 19.



PAPIER Z LNU POWSTAJE Z MIESZANKI KORY MORWY I WŁÓKIEN KONOPNYCH ORAZ 5% DOMIESZKI LNU. CHARAKTERYZUJE SIĘ DOSKONAŁĄ ABSORPCJĄ ATRAMENTU ORAZ WYSOKĄ ODPORNOŚCIĄ NA BLAKNIĘCIE. JEST IDEALNYM MATERIAŁEM DO DŁUGOTRWAŁEGO PRZECHOWYWANIA NOTATEK.

LINEN PAPER IS MADE FROM A MIXTURE OF MULBERRY BARK AND HEMP FIBERS, WITH A 5% FLAX ADMIXTURE. FEATURING AN EXCELLENT INK ABSORPTION AND HIGH RESISTANCE TO FADING. IT'S A PERFECT MATERIAL FOR LONG-TERM STORAGE OF NOTES.





NOTES / NOTEBOOK

TA SAMA
OPRAWA,
RÓŻNE
WNĘTRZA
SAME
COVER,
DIFFERENT
INTERIORS





KREATOR
ZWIZUALIZUJ SWÓJ
KALENDARZ/NOTES!

WYBIERZ MODEL,
RODZAJ OKLEINY I KOLOR.

DOŁÓŻ DODATKI, NP. GUMKI.

DOPASUJ DATOWNIK
I WGRAJ SWOJE LOGO.

CREATOR
VISUALIZE YOUR
CALENDAR/NOTEBOOK!

CHOOSE MODEL,
TYPE OF COVER AND COLOUR.

ADD ADDITIVES SUCH
AS ELASTICS.

MATCH THE DATE
AND UPLOAD YOUR LOGO.

[CALENDARS.COM.PL/KREATOR](https://calendars.com.pl/kreator)



KALENDARZ / CALENDAR

EFEKT WYPUKŁEJ FOLII 3D 3D RAISED FOIL EFFECT



inspiracja / inspiration

wymiar / size:

oprawa / cover*:

uszlachetnienie / refinement:

nakład / print run:

pod każdy format / for any format

papierowa / paper

folia 3D, lakier UV / 3D foil, UV varnish

min. 100 szt. / MOQ 100 pcs.

* NAROŻNIKI PROSTE LUB ZAOKRĄGLONE NA TEKSTURZE TWARDEJ. / WITH HARDCOVER, STRAIGHT OR ROUNDED CORNERS.

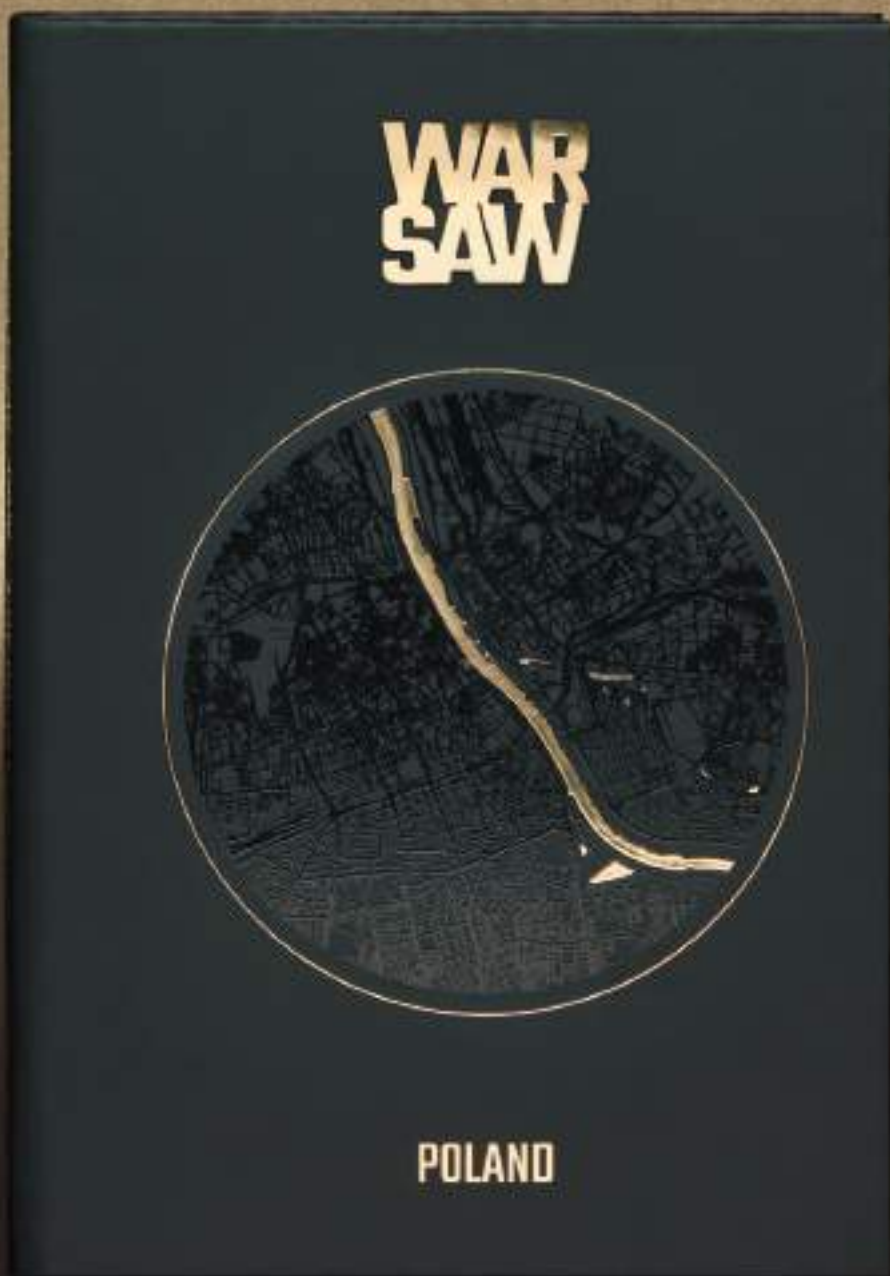

inspiracja / inspiration

wymiar / size:

oprawa / cover*:

uszlachetnienie / refinement:

nakład / print run:

pod każdy format / for any format

papierowa / paper

folia 3D, lakier UV / 3D foil, UV varnish

min. 100 szt. / MOQ 100 pcs.

* NAROŻNIKI PROSTE LUB ZAOKRĄGLONE NA TEKTURZE TWARDEJ. / WITH HARDCOVER, STRAIGHT OR ROUNDED CORNERS.

METALICZNY NADRUK W LŚNIĄCYM KOLORZE

METALLIC PRINT IN SHINY COLOUR



inspiracja / inspiration

produkt / product:

materiał / material:

uszlachetnienie / refinement:

pudełko, notes, kalendarz, banderola / box, notebook, calendar, banderole

papier / paper

folia 3D, lakier UV / 3D foil, UV varnish



inspiracja / inspiration

zestaw / set:

kalendarz + notes / calendar + notebook

oprawa / cover:

SENSO

metoda znakowania / marking method:

tłoczenie folią / foil debossing

materiał opakowania / packaging material:

papier / paper

uszlachetnienie opakowania / packaging refinement:

folia 3D, lakier UV / 3D foil, UV varnish

**TWOJA GRAFIKA
NA STRONACH
WYBRANEGO
KALENDARZA LUB NOTESU**

**YOUR DESIGN
ON THE PAGES OF YOUR
CHOSEN CALENDAR OR
NOTEBOOK**



**KALENDARZ/NOTES
W UKŁADZIE STANDARDOWYM
Z MOŻLIWOŚCIĄ PERSONALIZACJI.**

**UMIEŚĆ SWOJE LOGO, WŁASNĄ
GRAFIKĘ W PEŁNYM KOLORZE
LUB PODDRUK.**

**CALENDAR/NOTEBOOK
IN STANDARD LAYOUT
WITH POSSIBILITY OF
PERSONALISATION.**

**PLACE YOUR LOGO, INDIVIDUAL
FULL-COLOUR GRAPHICS OR
UNDERPRINT.**



**WYCHODZĄC NAPRZECIW
OCZEKIWANIOM NASZYCH
MIĘDZYNARODOWYCH KLIENTÓW,
OFERUJEMY MOŻLIWOŚĆ DRUKU
KALENDARZA **WE WSZYSTKICH
JĘZYKACH.****

**TO MEET THE EXPECTATIONS OF
OUR INTERNATIONAL CUSTOMERS,
WE OFFER THE POSSIBILITY OF PRINTING
THE CALENDAR **IN ALL LANGUAGES.****

**KALENDARZ W TWOIM JĘZYKU, W TRZECH UNIKALNYCH STYLACH!
CALENDAR IN YOUR LANGUAGE, IN THREE UNIQUE STYLES!**

510D 514T 516 *

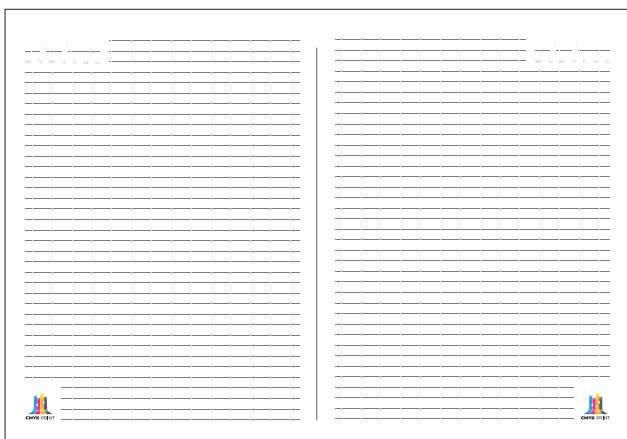
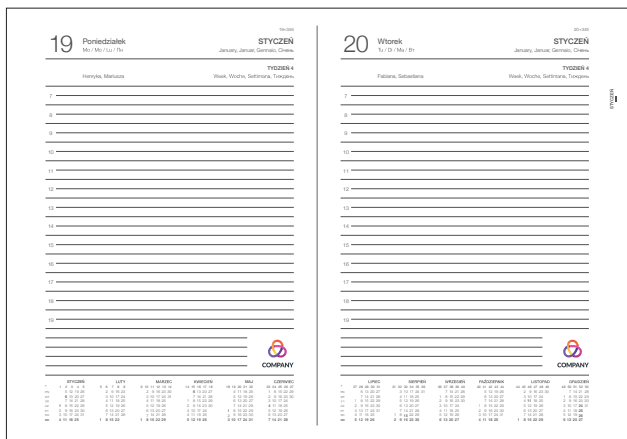
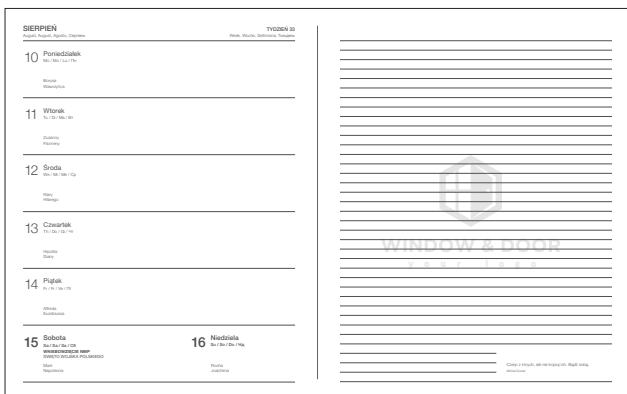
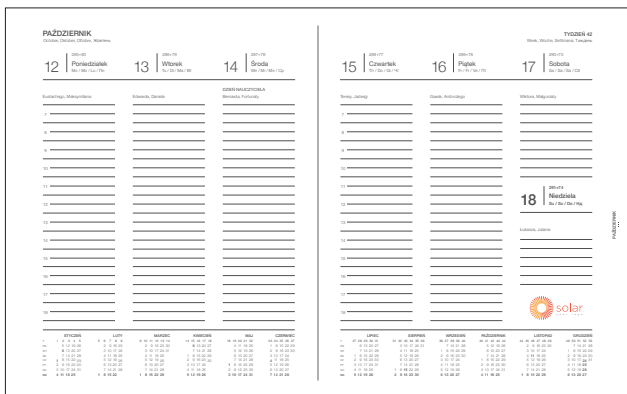

ZAMÓWIENIE JUŻ OD

100 SZT.

ORDER FROM 100 PCS.

**BLOKI AUTORSKIE SZYTO-KLEJONE /
CUSTOMISED SEWN-GLUED BLOCKS**

wymiar / size:

pod każdy format / for any format

oprawa / cover:

według wzornika / according to the template

papier / paper:

biały / white

chamois / ivory

recykling / recycled

trawa / grass – dotyczy notesów / applies to notebooks

len / linen **NEW**

kamień / stone

druk / print:

cyfrowy / digital



YOUR LANGUAGE. YOUR STYLE.
YOUR CALENDAR.

TWÓJ JĘZYK. TWÓJ STYL.
TWÓJ KALENDARZ.





**We offer book calendars with customised language interiors.
Perfect for international workspaces or as a personalised gift.**

Oferujemy kalendarze książkowe z możliwością wyboru bloku w dowolnym języku.
Idealne do pracy w międzynarodowym środowisku lub jako spersonalizowany prezent.

Applies to calendars and planner: / Dotyczy kalendarzy i planera: 510D, 514T, 516.

BLOKI AUTORSKIE NA RINGACH / CUSTOMISED BLOCKS WITH RINGS **NEW**



ZAMÓWIENIE JUŻ OD

50 SZT.

ORDER FROM 50 PCS.

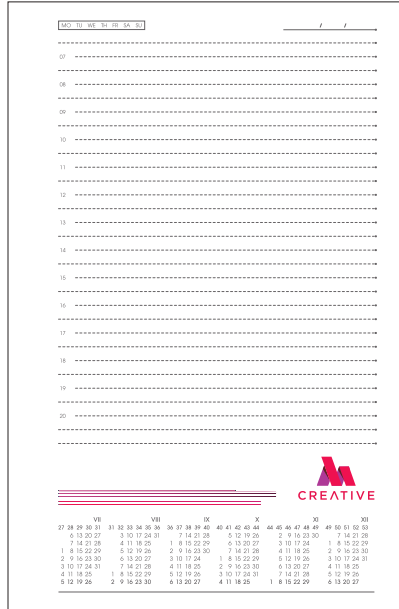
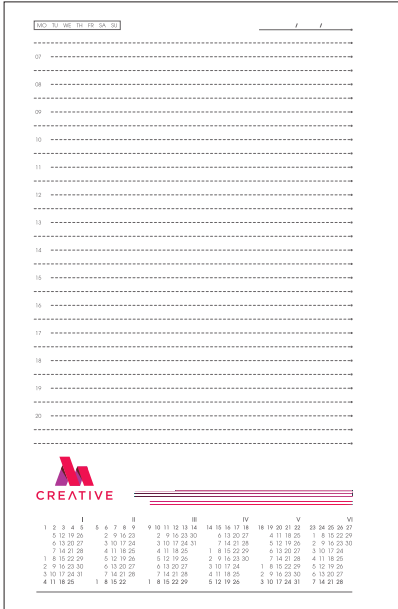

NOTES AUTORSKI WEDŁUG
INDYWIDUALNEGO PROJEKTU.
SZEROKI WACHLARZ ZASTOSOWAŃ
BRANŻOWYCH.

NOTES, KTÓRY ŁĄCZY
FUNKCJONALNOŚĆ
Z ELEGANCKIM DESIGNEM.

**TO TY DECYDUJESZ,
JAKIE BĘDZIE JEGO WNĘTRZE!**

AUTHOR'S NOTEBOOK ACCORDING
TO **INDIVIDUAL DESIGN.**
WIDE RANGE OF INDUSTRY
APPLICATIONS.
A NOTEBOOK COMBINING
FUNCTIONALITY WITH
ELEGANT DESIGN.

**YOU DECIDE
WHAT ITS INTERIOR WILL BE!**

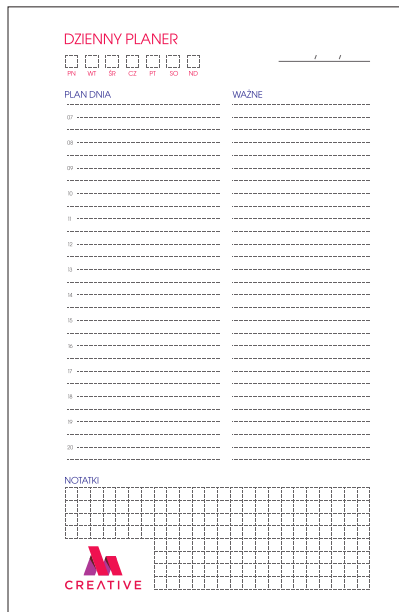
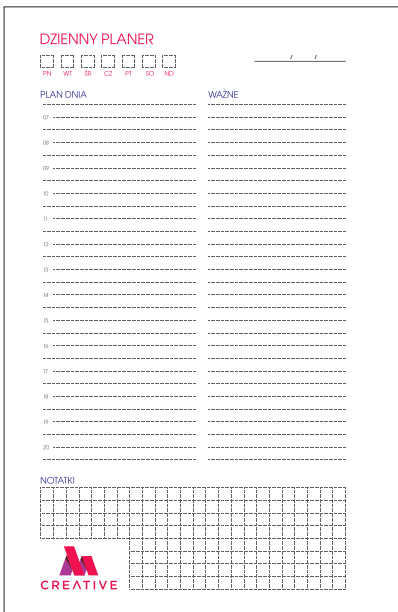

**BLOKI AUTORSKIE NA RINGACH /
CUSTOMISED BLOCKS WITH RINGS**

wymiar / size:

~A5, ~B5, ~A4

oprawa / cover:

według wzornika, z wykluczeniem /
according to the template, except -
rPET, LINO

papier / paper:

biały / white
chamois / ivory
recycling / recycled
trawa / grass - dotyczy notesów /
applies to notebooks
len / linen ^{NEW}
kamień / stone

druk / print:

cyfrowy / digital

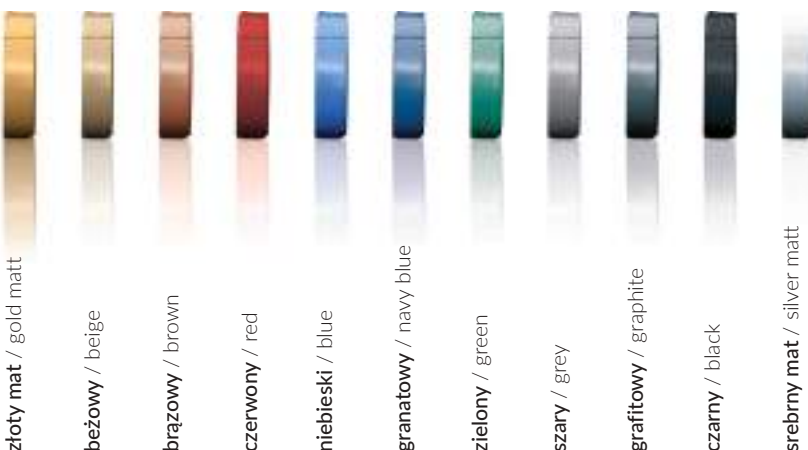

złoty mat / gold matt

beżowy / beige

brązowy / brown

czerwony / red

niebieski / blue

granatowy / navy blue

zielony / green

szary / grey

grafitowy / graphite

czarny / black

srebrny mat / silver matt

PAPIER Z NASIONAMI / PAPER WITH SEEDS



WKLEJKA / INSERT PAGE

ROSNĄCY PAPIER PRODUKOWANY JEST Z PAPIERU BIODEGRADOWALNEGO POPRZEC UMIESZCZENIE W NIM NASION KWIATÓW POLNYCH: STOKROTKI, NIEZAPOMINAJKI, MAKU POLNEGO I FIRLETKI, CO NADAJE MU NATURALNĄ STRUKTURĘ. **W 100% BIODEGRADOWALNY!** JEST ZRÓWNOWAŻONYM, EKOLOGICZNYM I PRZYJAZNYM DLA ŚRODOWISKA RODZAJEM PAPIERU.

THE GROWING PAPER IS MADE OF BIODEGRADABLE PAPER BY PLACING SEEDS OF WILDFLOWERS IN IT: DAISIES, FENNEL, FIELD POPPIES AND FIRLETS, WHICH GIVES IT A NATURAL STRUCTURE.

100% BIODEGRADABLE! IT IS A SUSTAINABLE, ECOLOGICAL AND ENVIRONMENTALLY FRIENDLY TYPE OF PAPER.

WSTAWKA / INSERT

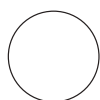

1 - $\varnothing 90$ mm



3 - 95 × 80 mm



5 - 68 × 90 mm



7 - 95 × 80 mm



2 - 80 × 90 mm



4 - 95 × 60 mm



6 - 90 × 90 mm

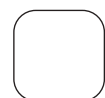

8 - 90 × 90 mm

PAPIER Z NASIONAMI

paper with seeds



Zobacz,
co wyrośnie!
witness the blossom

Posadź.
Podlewaj!
sow & flow!

Z NATURE DO NATURE / FROM NATURE TO NATURE





**DZIĘKI PROGRAMOWI
POSADZIMY.PL
ZA KAŻDE ZAKUPIONE U NAS
100 KALENDARZY
ZASADZIMY 1 DRZEWO.**

THANKS TO POSADZIMY.PL
CAMPAIGN, FOR EVERY
100 CALENDARS
PURCHASED FROM US,
WE ARE GOING
TO PLANT 1 TREE.

MIERZALNE EFEKTY / MEASURABLE EFFECTS:

5385

osób oddycha świeżym powietrzem / people are breathing fresh air

466 114 kg

zwróconego papieru / amount of paper returned

8921 m²

powierzchni lasu / area of the forest

48 222 kg

pochłanianego CO₂ na rok / CO₂ absorption per year

100 KALENDARZY
CALENDARS



=

1 DRZEWO
TREE



**WSPÓLNIE POSADZILIŚMY
8037 DRZEW.**

TOGETHER, WE PLANTED
8037 TREES.



tłoczenie / debossing



tłoczenie folią / foil debossing



druk sublimacyjny / sublimation printing



druk UV monochromatyczny biały /
UV white monochrome printing



druk UV kolorowy / UV colour printing



szycie kreatywne / creative stitching



KLASYCZNA OKLEINA W ATRAKCYJNEJ FORMIE

CLASSIC COVER IN ATTRACTIVE FORM

inspiracja / inspiration

rok / year design:

drukowany / printed

oprawa / cover:

CANVAS

metoda znakowania /
marking method:

druk UV, szycie kreatywne, tłoczenie /
UV printing, creative stitching, debossing

ZNAKOWANIE OPRAW / COVER MARKING

OPRAWA COVER	TŁOCZENIE DEBOSSING	TŁOCZENIE FOLIA FOIL DEBOSSING	GRAWER ENGRAVING	SZYCIE KREATYWNE CREATIVE STITCHING	DRUK PRINTING
LINO					✓ druk cyfrowy CMYK, DTF / CMYK digital printing, DTF
SENSO	✓	✓	✓	✓	✓ druk UV / UV printing
LAVA	✓		✓	✓	✓ druk UV / UV printing
rPET					✓ druk sublimacyjny / sublimation printing
QUERK					✓ druk UV / UV printing
RE-COVER				✓	✓ druk UV / UV printing
NATURA	✓	✓	✓	✓	✓ druk cyfrowy CMYK / CMYK digital printing
GAMBO	✓		✓	✓	✓ druk UV / UV printing
CROSS	✓		✓	✓	✓ druk UV / UV printing
CANVAS	✓		✓	✓	✓ druk UV / UV printing
IDEO	✓	✓	✓	✓	✓ druk UV / UV printing
PIKO	✓		✓	✓	✓ druk UV / UV printing
GUMA	✓	✓	✓	✓	✓ druk UV / UV printing
IMAGE	✓	✓	✓	✓	✓ druk UV / UV printing
CARBON	✓		✓	✓	✓ druk UV / UV printing
KRAFT	✓	✓	✓	✓	✓ druk UV / UV printing
VIVELA	✓	✓	✓	✓	✓ druk UV / UV printing

SENSO



jasnobrązowy / light brown ^{NEW}



brązowy / brown ^{NEW}

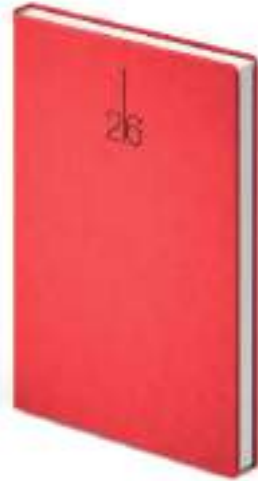

czerwony / red ^{NEW}



szary / grey ^{NEW}



granatowy / navy blue



zielony / green



grafitowy / graphite



czarny / black

SENSO

rok / year design:

15



inspiracja / inspiration

rok / year design:	10
oprawa / cover:	SENSO
metoda znakowania / marking method:	łoczenie / debossing
dodatek / add-on:	F1
łączenie opraw / cover combinations:	34

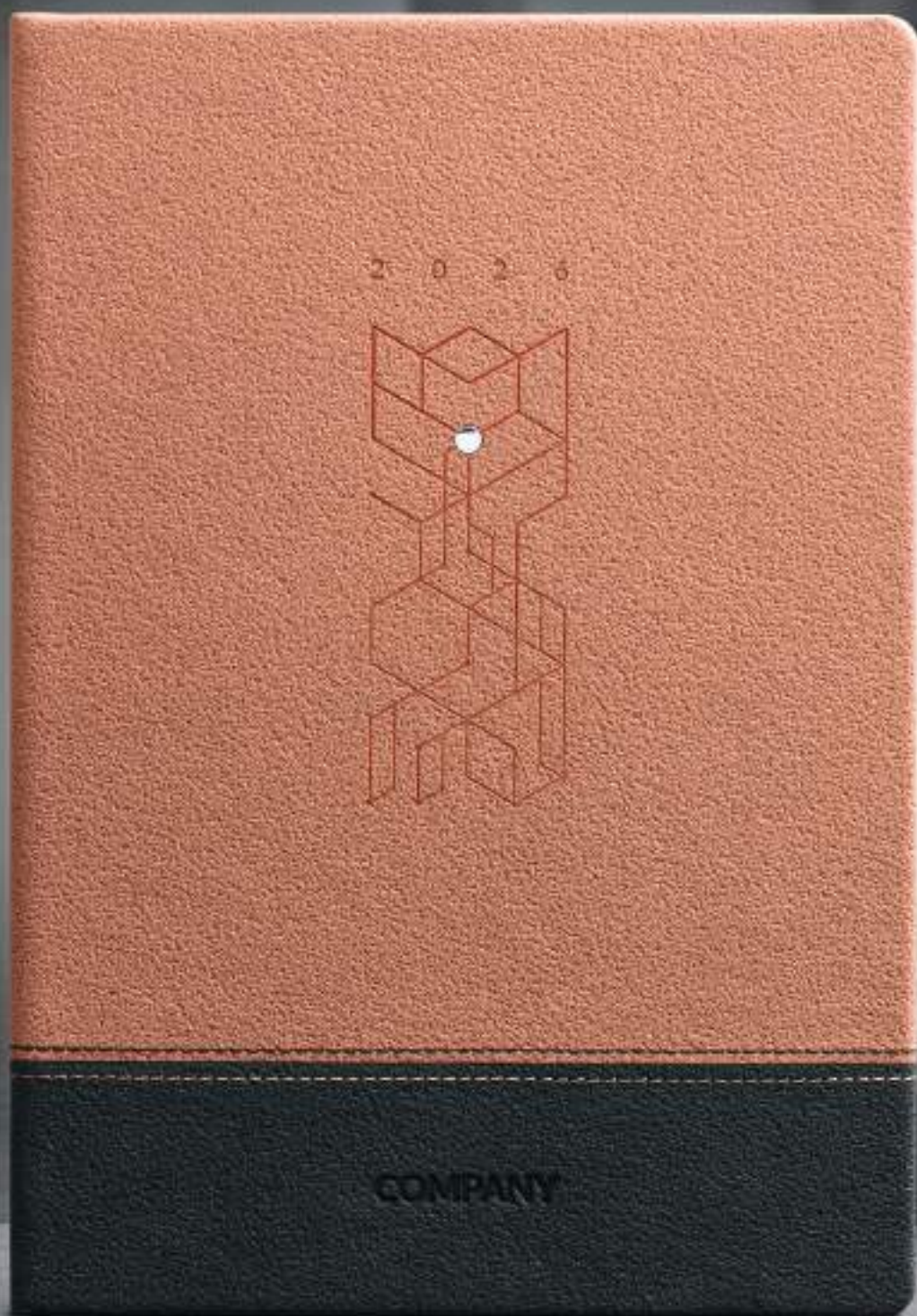

inspiracja / inspiration

rok / year design:

6

oprawa / cover:

LAVA + LAVA

metoda znakowania / marking method:

tłoczenie / debossing

dodatek / add-on:

M17B

łączenie opraw / cover combinations:

9A

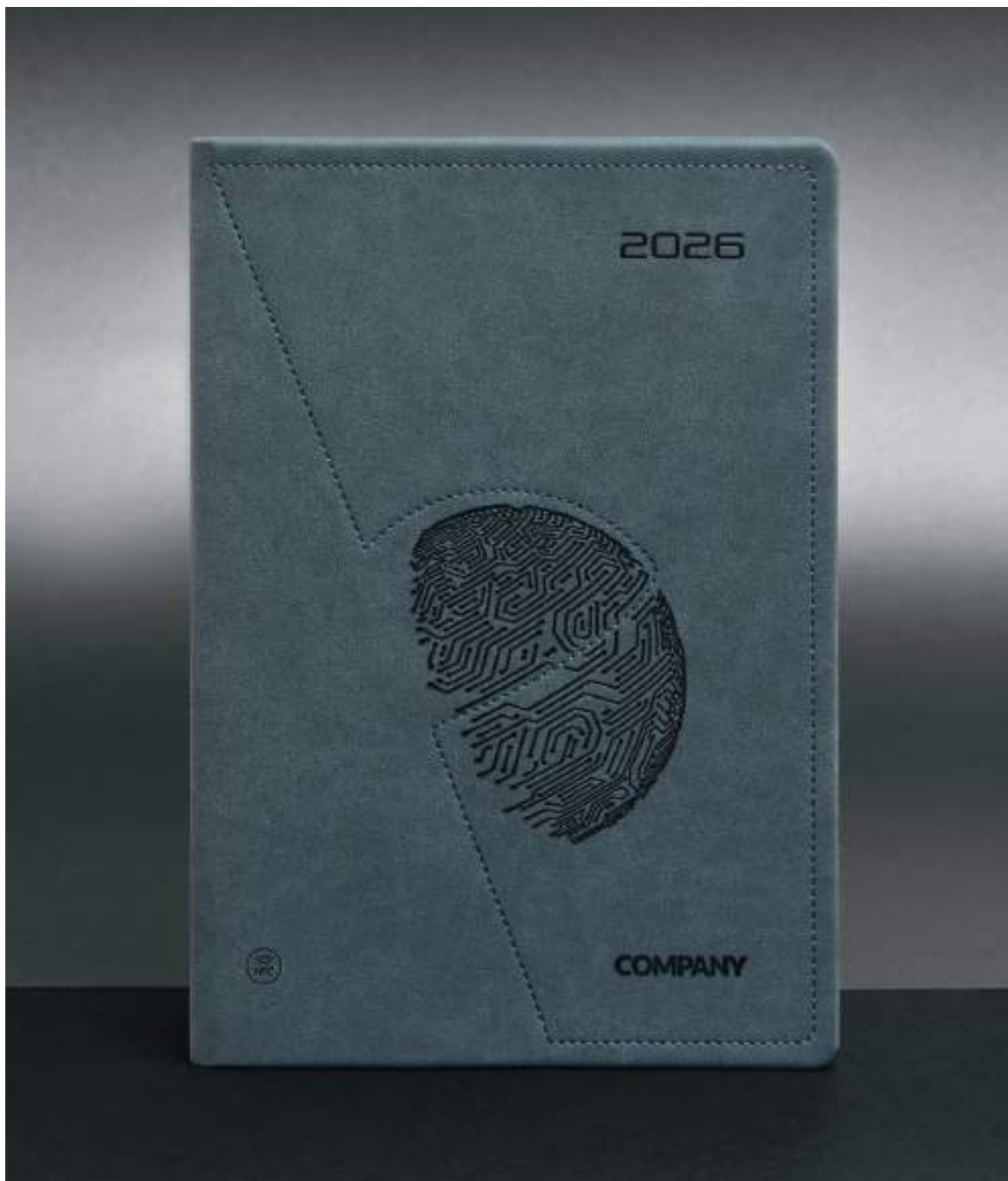

inspiracja / inspiration

rok / year design:

2B

oprawa / cover:

SENSO

metoda znakowania / marking method:

tłoczenie, szycie kreatywne / debossing, creative stitching

dodatek / add-on:

NFC

LAVA



jasnoniebieski / light blue **NEW**



niebieski / blue **NEW**



koralowy / coral **NEW**



brązowy / brown



granatowy / navy blue



grafitowy / graphite



czarny / black

LAVA

rok / year design:

8



inspiracja / inspiration

rok / year design:

M4

oprawa / cover:

LAVA

metoda znakowania / marking method:

tłoczenie / debossing

dodatek / add-on:

M16



beżowy / beige

LINO

rok / year design:

drukowany / printed

NATURALNY LEN
natural linen

WORKI BAWĘLNIANE / COTTON BAGS

wymiar / size:

kalendarze / calendars: 501D, 502T, 511T, notes / notebook A4

26 × 38 cm

kalendarze / calendars: 507T, 508D, 512T, 514T, 516, notes / notebook B5

22 × 34 cm

kalendarze / calendars: 503D, 509T, 510D, 517

19 × 29 cm

kalendarze / calendars: 504T, 506D, notesy / notebooks: A5, A6

17 × 30 cm

materiał / material:

bawełna / cotton

metoda znakowania / marking method:

DTF



inspiracja / inspiration

rok / year design:

drukowany / printed

oprawa / cover:

LINO

metoda znakowania / marking method:

druk cyfrowy CMYK / CMYK digital printing

opakowanie / packaging:

worek bawełniany / cotton bag

metoda znakowania / marking method:

DTF

2 0 2 6



COMPANY

inspiracja / inspiration

rok / year design:

oprawa / cover:

metoda znakowania / marking method:

drukowany / printed

LINO

druk cyfrowy CMYK / CMYK digital printing





ZESKANUJ, ABY POBRAĆ
KATALOG Z PRODUKTAMI
SUBLIMACYJNYMI

scan to download a catalogue
with sublimation products



SUBLIMACJA
NIE TYLKO
KALENDARZE...

sublimation
not only calendars...



rPET



DRUK SUBLIMACYJNY / SUBLIMATION PRINTING



biały / white

rPET JEST MATERIAŁEM RECYKLINGOWYM POZYSKIWANYM W 100% Z ODPADÓW POKONSUMPCYJNYCH, NAJCZĘŚCIEJ Z BUTELEK TYPU PET. NA 1 m² WYKORZYSTUJE SIĘ 12 BUTELEK 1,5-LITROWYCH. MATERIAŁ TEN JEST PRZEZNACZONY DO DRUKU SUBLIMACYJNEGO W KOLORACH CMYK.

rPET IS A RECYCLABLE MATERIAL OBTAINED FROM 100% POST-CONSUMER WASTE, MOST OFTEN FROM PET BOTTLES. 12 BOTTLES OF 1.5 LITERS ARE USED PER 1 m². THE RECYCLED MATERIAL IS INTENDED FOR SUBLIMATION PRINTING ACCORDING TO CMYK.

rPET

rok / year design:
drukowany / printed

MOŻLIWOŚĆ PERSONALIZACJI
W DOWOLNYM KOLORZE.
POSSIBILITY OF PERSONALISATION
IN ANY COLOUR.



rPET
B5





inspiracja / inspiration

oprawa / cover:

metoda znakowania / marking method:

dodatek / add-on:

rPET

druk sublimacyjny / sublimation printing

gumka 10 mm, szlufka na długopis / 10 mm elastic band, pen holder

RE-COVER



beżowy / beige



grafitowy / graphite



RE-COVER

rok / year design:

drukowany / printed



OPRAWA **RE-COVER** WYKONANA JEST Z SUROWCA POZYSKANEGO W PROCESIE RECYKLINGU SKÓR NATURALNYCH. JEST ONA W PEŁNI ZGODNA Z ROZPORZĄDZENIEM REACH ORAZ KONWENCJĄ WASHINGTONSKĄ CITES. PARAMETRY WYTRZYMAŁOŚCI SĄ OKREŚLONE METODĄ EN ISO 3376:2011.

RE-COVER IS MADE FROM MATERIAL OBTAINED THROUGH THE RECYCLING PROCESS OF NATURAL LEATHERS. IT IS FULLY COMPLIANT WITH THE REACH REGULATION AND THE WASHINGTON CITES CONVENTION. THE STRENGTH PARAMETERS ARE DETERMINED BY THE EN ISO 3376:2011 METHOD.

inspiracja / inspiration

rok / year design: drukowany / printed

oprawa / cover: **RE-COVER**

metoda znakowania / druk UV / marking method: UV printing



inspiracja / inspiration

rok / year design:

oprawa / cover:

metoda znakowania / marking method:

dodatek / add-on:

drukowany / printed

RE-COVER

druk UV / UV printing

gumka 10 mm / 10 mm elastic band

QUERK



beżowy / beige

QUERK

rok / year design:

drukowany / printed

KOREK TO NATURALNY MATERIAŁ POZYSKIWANY Z KORY DĘBU KORKOWEGO. JEST MATERIAŁEM W PEŁNI EKOLOGICZNYM, A DODATKOWO WEGAŃSKIM. NIE MA DWÓCH TAKICH SAMYCH FRAGMENTÓW, CO STANOWI O JEGO WYJĄTKOWOŚCI.

CORK IS A NATURAL MATERIAL OBTAINED FROM THE BARK OF THE QUERKUS SUBER. IT IS A FULLY ECOLOGICAL MATERIAL AND, ON TOP OF THAT, VEGAN. THERE ARE NO TWO IDENTICAL PIECES, WHICH MAKES THIS MATERIAL UNIQUE.



**ZMIENŃ CHARAKTER
SWOJEGO KALENDARZA
DODATKIEM **M16**
I DŁUGOPISEM **G0072**
Z ELEMENTEM KORKOWYM.**

CHANGE THE CHARACTER
OF YOUR CALENDAR WITH
THE ADDITION OF **M16**
AND PEN **G0072**
WITH CORK ELEMENT.



inspiracja / inspiration

oprawa / cover:

metoda znakowania / marking method:

QUERK

druk UV / UV printing

SZYCIE KREATYWNE / CREATIVE STITCHING



1

rok / year design: 15

oprawa / cover: VIVELA



2

rok / year design: 2B

oprawa / cover: KRAFT



3

rok / year design: 6

oprawa / cover: CANVAS



4

rok / year design: M4

oprawa / cover: SENSO



5

rok / year design: 6

oprawa / cover: CANVAS



6

rok / year design: 5

oprawa / cover: CANVAS

dodatek / add-on: M17B

metoda znakowania / marking method: szycie kreatywne, tłoczenie / creative stitching, debossing

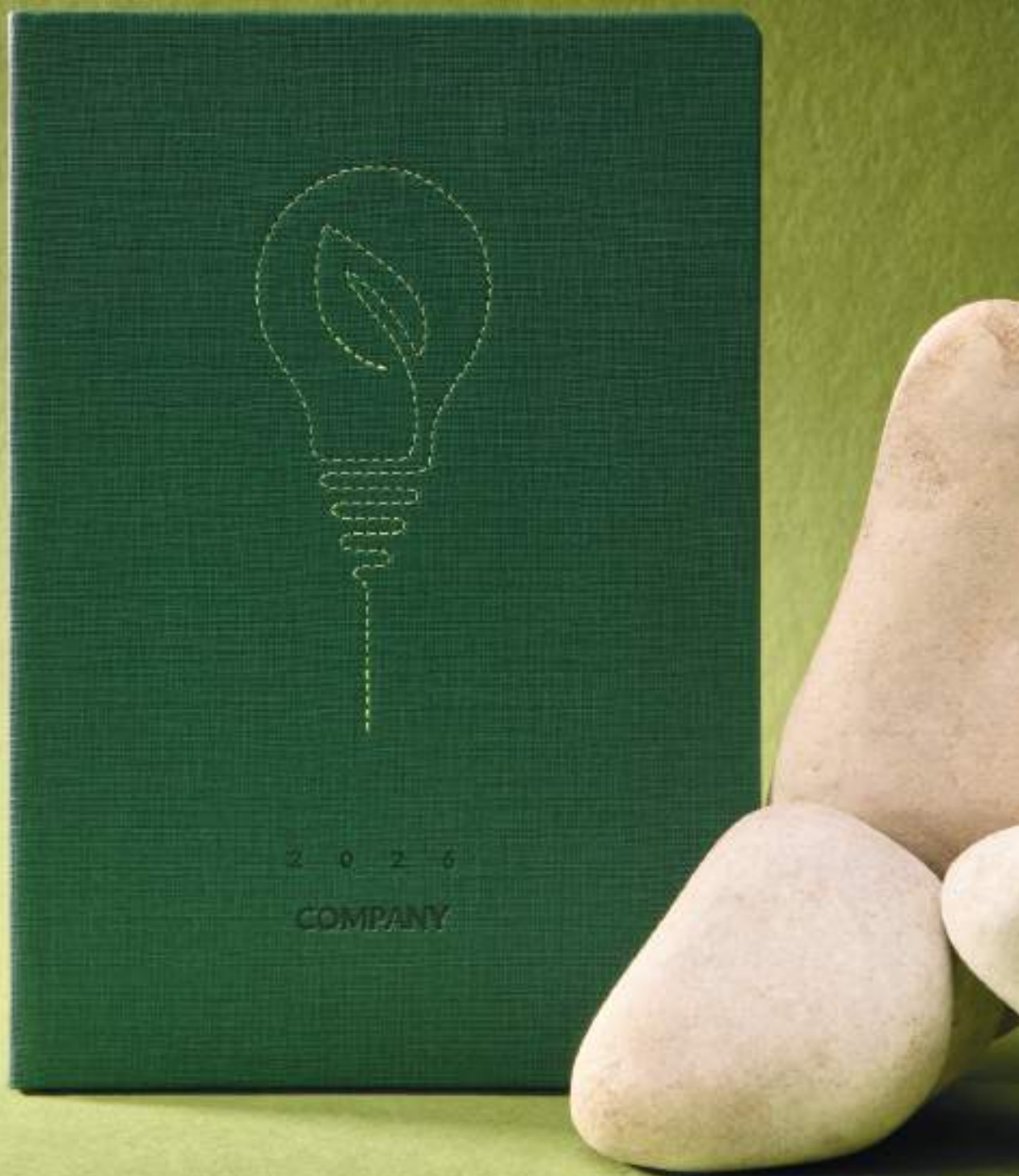

inspiracja / inspiration

rok / year design:

6

oprawa / cover:

CANVAS

metoda znakowania / marking method:

łtroczenie, szycie kreatywne / debossing, creative stitching



inspiracja / inspiration

rok / year design: drukowany / printed
oprawa / cover: NATURA
metoda znakowania /
marking method: druk cyfrowy w jednym kolorze /
digital printing in one colour

inspiracja / inspiration

rok / year design: 6
oprawa / cover: NATURA
metoda znakowania /
marking method: tłoczenie / debossing
dodatek / add-on: M20A

GAMBO



zielony / green



brązowy / brown



szary / grey



czarny / black

GAMBO

rok / year design:

14



inspiracja / inspiration

rok / year design: **drukowany / printed**

oprawa / cover: **GAMBO**

metoda znakowania / marking method: **łtłczenie / debossing**

dodatek / add-on: **B2**

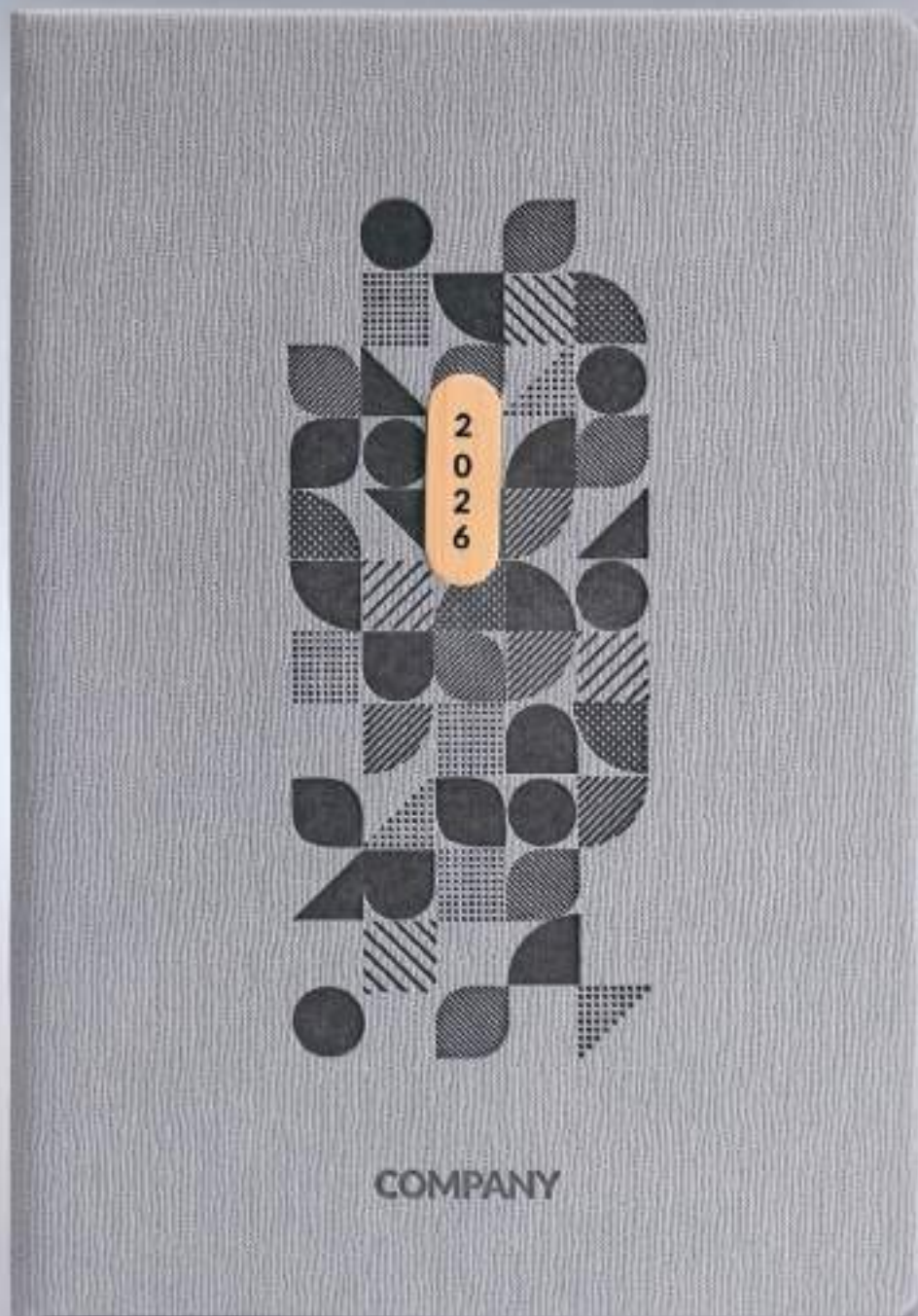

inspiracja / inspiration

rok / year design:

oprawa / cover:

metoda znakowania / marking method:

dodatek / add-on:

drukowany / printed

GAMBO

łłoczenie / debossing

B4

CROSS



pomarańczowy / orange



seledynowy / willow-green ^{NEW}



zielony / green ^{NEW}



fioletowy / purple ^{NEW}



niebieski / blue ^{NEW}



granatowy / navy blue



grafitowy / graphite ^{NEW}



czarny / black

CROSS

rok / year design:

11

PIKO



brązowy / brown



czarny / black

PIKO

rok / year design:

1B



inspiracja / inspiration

rok / year design:

6

oprawa / cover:

CROSS

metoda znakowania /
marking method:

tłoczenie, szycie kreatywne /
debossing, creative stitching

inspiracja / inspiration

rok / year design:

6

oprawa / cover:

PIKO

metoda znakowania /
marking method:

tłoczenie, szycie kreatywne /
debossing, creative stitching

GUMA

Druk UV / UV PRINTING



biały / white



szary / grey



granatowy / navy blue



czerwony / red



czarny / black

GUMA

rok / year design:

19



inspiracja / inspiration

rok / year design: drukowany / printed

oprawa / cover: GUMA

metoda znakowania / druk UV / marking method: UV printing

dodatek / add-on: gumka 10 mm / 10 mm elastic band



inspiracja / inspiration

rok / year design:

oprawa / cover:

metoda znakowania / marking method:

drukowany / printed

GUMA

druk UV / UV printing



czarny / black



szary / grey



niebieski / blue



zielony / green



seledynowy / willow-green



turkusowy / turquoise



magenta / magenta



pomarańczowy / orange



żółty / yellow



granatowy / navy blue



czerwony / red



beżowy / beige

VIVELA

rok / year design:

12



inspiracja / inspiration

oprawa / cover:

VIVELA

dodatek / add-on:

gumka 10 mm / 10 mm elastic band + M22, M23, M24
z naklejką / with sticker



inspiracja / inspiration

rok / year design:

5

oprawa / cover:

VIVELA

metoda znakowania / marking method:

łtloczenie / debossing

dodatek / add-on:

M20B, gumka 10 mm / M20B, 10 mm elastic band



inspiracja / inspiration

rok / year design:

2B

oprawa / cover:

VIVELA

metoda znakowania / marking method:

grawer / engraving

dodatek / add-on:

gumka 10 mm / 10 mm elastic band + **M15**



1

matryca / stamp: 1

rok / year design: 6

oprawa / cover: NATURA

metoda znakowania /
marking method: tłoczenie,
szycie
kreatywne /
debossing,
creative
stitching



2

matryca / stamp: 12

rok / year design: drukowany /
printed

oprawa / cover: SENSO

metoda znakowania /
marking method: tłoczenie /
debossing

dodatek / add-on: B2



3

matryca / stamp: 3

rok / year design: 6

oprawa / cover: LAVA

metoda znakowania /
marking method: tłoczenie,
szycie
kreatywne /
debossing,
creative
stitching

dodatek / add-on: M17C



4

matryca / stamp: 7

rok / year design: 6

oprawa / cover: LAVA

metoda znakowania /
marking method: tłoczenie /
debossing



5

matryca / stamp: 5

oprawa / cover: IDEO

metoda znakowania /
marking method: tłoczenie /
debossing

dodatek / add-on: M19



6

matryca / stamp: 10

rok / year design: 5

oprawa / cover: SENSO

metoda znakowania /
marking method: tłoczenie /
debossing

dodatek / add-on: M20B



7

matryca / stamp:	2
rok / year design:	M4
oprawa / cover:	GUMA
metoda znakowania / marking method:	łtczenie / debossing



8

matryca / stamp:	14
rok / year design:	17
oprawa / cover:	NATURA
metoda znakowania / marking method:	łtczenie / debossing



9

matryca / stamp:	9
oprawa / cover:	SENSO
metoda znakowania / marking method:	łtczenie / debossing



10

matryca / stamp:	11
rok / year design:	drukowany / printed
oprawa / cover:	GAMBO
metoda znakowania / marking method:	łtczenie / debossing
dodatek / add-on:	B4



11

matryca / stamp:	6
rok / year design:	M3
oprawa / cover:	IDEO
metoda znakowania / marking method:	łtczenie / debossing



12

matryca / stamp:	4
rok / year design:	6
oprawa / cover:	LAVA + SENSO
metoda znakowania / marking method:	łtczenie, szycie kreatywne / debossing, creative stitching
dodatek / add-on:	F1
łtczenie opraw / cover combinations:	32

CANVAS

Druk UV / UV PRINTING



biały / white



czerwony / red



zielony / green



niebieski / blue



granatowy / navy blue



beżowy / beige



brązowy / brown



szary / grey



czarny / black

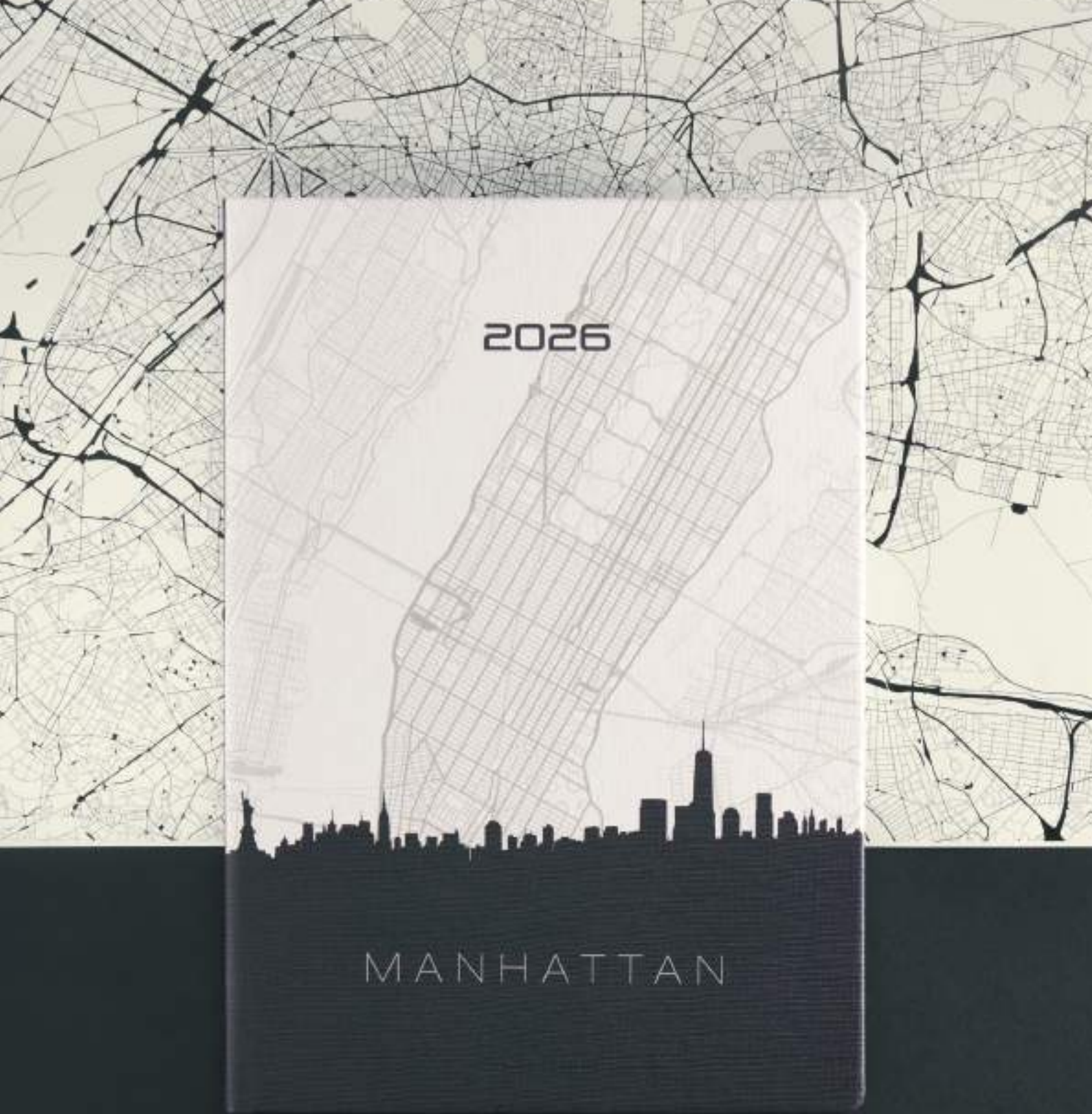

2026

MANHATTAN

< **CANVAS**

rok / year design:
21B

inspiracja / inspiration

rok / year:

oprawa / cover:

metoda znakowania / marking method:

drukowany / printed

CANVAS

druk UV / UV printing

CANVAS LINE



LINE 1

rok / year design: 6



LINE 8

rok / year design: 5

dodatek / add-on: M17B



LINE 9 ^{NEW}

rok / year design: 6

PODKREŚL SWÓJ STYL NOWĄ, KOLOROWĄ NITKĄ!
EMPHASISE YOUR STYLE WITH NEW COLOURFUL SEWING!

KOLOR OPRAWY I NICI DO WYBORU. / COVER COLOURS AND SEWING THREADS TO CHOOSE.



LINE 10 ^{NEW}

rok / year design: 7



LINE 11 ^{NEW}

rok / year design: 5



LINE 12 ^{NEW}

rok / year design: 13C

metoda znakowania / marking method: szycie kreatywne, tłoczenie / creative stitching, debossing

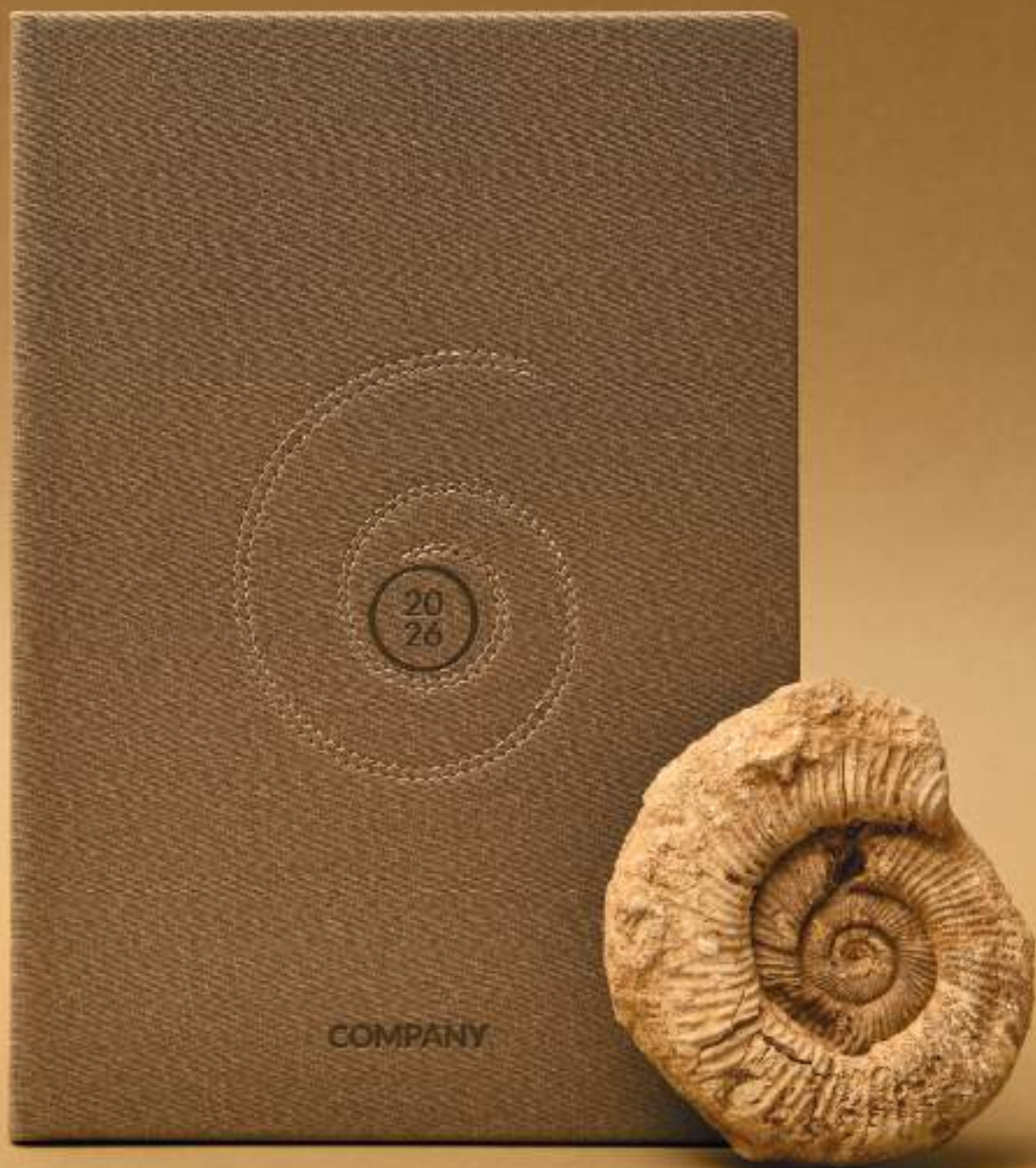

inspiracja / inspiration

rok / year design:

11

oprawa / cover:

CANVAS

metoda znakowania / marking method:

tłoczenie, szycie kreatywne / debossing, creative stitching

CANVAS PRINT ^{NEW}



1

rok / year design: 18A



2

rok / year design: 7



3

rok / year design: 15A

NOWE PERSPEKTYWY! BEZ OGRANICZEŃ DRUKUJ WŁASNĄ GRAFIKĘ W DOWOLNYM KSZTAŁCIE.
NEW PERSPECTIVES! PRINT YOUR OWN GRAPHICS IN ANY SHAPE WITHOUT RESTRICTIONS.

KOLOR OPRAWY I NICI DO WYBORU. / COVER COLOURS AND SEWING THREADS TO CHOOSE.



4

rok / year design: 6



5

rok / year design: M4



6

rok / year design: drukowany /
printed

metoda znakowania / marking method: druk UV, szycie, tłoczenie / UV printing, stitching, debossing



inspiracja / inspiration

rok / year design: **6**
oprawa / cover: **CANVAS**
metoda znakowania /
marking method: **druk UV, tłoczenie, szycie /
UV printing, debossing, stitching**

inspiracja / inspiration

rok / year design: **M4**
oprawa / cover: **CANVAS**
metoda znakowania /
marking method: **druk UV, tłoczenie, szycie /
UV printing, debossing, stitching**

KRAFT



grafitowy / graphite

KRAFT

rok / year design:

3

inspiracja / inspiration

rok / year design:

5

oprawa / cover:

KRAFT

metoda znakowania / marking method:

łtłoczenie / debossing*

dodatek / add-on:

M20B

* WYBÓR MATRYC Z KOLEKCJI NA STRONACH 94-97. / SELECTION OF STAMPS FROM THE COLLECTION ON PAGES 94-97.

IMAGE



czarny / black

IMAGE

rok / year design:

13B

inspiracja / inspiration

rok / year design:

19B

oprawa / cover:

IMAGE

metoda znakowania / marking method:

tłoczenie, szycie kreatywne / debossing, creative stitching

Druk UV / UV PRINTING



biały / white



seledynowy / willow-green



czzerwony / red



granatowy / navy blue



czarny / black



szary / grey



jasnobrązowy / light brown



bordowy / maroon

IDEO

rok / year design:

16B



inspiracja / inspiration

rok / year design: 20B
oprawa / cover: IDEO

inspiracja / inspiration

rok / year design: 21B
oprawa / cover: IDEO
metoda znakowania /
marking method: tłoczenie / debossing



ARROWS NEW



BUBBLES NEW



CARO



VENUS



SQUARES



STRIPES NEW



DROP



DUNES



HILLS



CARBON



granatowy / navy blue



czarny / black



szary / grey

CARBON

rok / year design:

M3



granatowy + zielony / navy blue + green



czarny + żółty / black + yellow



szary + turkusowy / grey + turquoise

CARBON LUNGO

rok / year design:

M4

oprawa / cover:

CARBON + VIVELA

łączenie opraw / cover combinations:

30



inspiracja / inspiration

oprawa / cover: **CARBON**
metoda znakowania /
marking method: tłoczenie / debossing
dodatek / add-on: gumka 10 mm / 10 mm elastic band + M23
z naklejką epoksydową / with epoxy sticker

inspiracja / inspiration

rok / year design: **M4**
oprawa / cover: **CARBON + VIVELA**
łączenie opraw /
cover combinations: **30**

KALENDARZE BIURKOWE / DESK CALENDARS



KALENDARZ BIURKOWY TYGODNIOWY Z KALENDARIUM 505T / 505T WEEKLY DESK CALENDAR

rok / year:	2B
kalendarz / calendar*:	stojący / standing lub /or leżący / lying
oprawa / cover**:	według wzornika / according to the template
metoda znakowania / marking method:	tłoczenie / debossing

* LAYOUT – SZCZEGÓŁY NA STRONACH 116-117. / SPECIFICATION ON PAGES 116-117.

** RODZAJ I KOLOR OPRAWY DO WYBORU, Z WYKLUCZENIEM rPET I RE-COVER. / TYPE AND COLOUR OF THE COVER MATERIAL ACCORDING TO YOUR CHOICE, EXCLUDING rPET AND RE-COVER COVERS.



KALENDARZ BIURKOWY PIRAMIDKA / PYRAMID DESK CALENDAR **NEW**

numer katalogowy / catalogue number:

P0306

kalendarz / calendar:

stojący / standing

wymiar / size:

~195 × 210 × 12 mm – produkt po złożeniu / product after assembly

oprawa / cover:

papierowa + folia / paper + foil

metoda znakowania / marking method:

druk cyfrowy CMYK / CMYK digital printing

inne / other:

12 kartek z kalendarium o wymiarach 204 × 99 mm, dwa bloczki o wymiarach 70 × 70 mm po 50 kartek z papieru z kamienia i offsetowego + znaczniki kolorowe w pięciu kolorach po 20 sztuk / 12 calendar sheets 204 × 99 mm, two 70 × 70 mm pads with 50 sheets of stone paper and offset paper each + 20 coloured markers in five colours



KALENDARZ BIURKOWY TYGODNIOWY 518T Z ORGANIZEREM / 518T WEEKLY DESK CALENDAR WITH ORGANISER

rok / year:	13
kalendarz / calendar*:	leżący / lying
wymiar / size:	~205 × 210 × 13 mm – produkt po złożeniu / product after assembly
oprawa / cover**:	CANVAS – szary, granatowy lub czarny / grey, navy blue or black
metoda znakowania / marking method:	tłoczenie / debossing
inne / other:	wycięcie pod długopis i telefon / cut-out for pen and mobile phone

* LAYOUT – SZCZEGÓŁY NA STRONACH 116-117. / SPECIFICATION ON PAGES 116-117.

** WYBÓR INNEJ OKLEINY MOŻLIWY OD 500 SZTUK. / CHOICE OF OTHER COVER POSSIBLE FROM 500 PCS.



KALENDARZ BIURKOWY MIESIĘCZNY Z ŁADOWARKĄ INDUKCYJNĄ / MONTHLY DESK CALENDAR WITH WIRELESS CHARGER

numer katalogowy / catalogue number:	G0085
kalendarz / calendar*:	stojący / standing
wymiar / size:	~180 × 135 × 14 mm
materiał / material:	bambus + rPET / bamboo + rPET
metoda znakowania / marking method:	druk UV / UV printing
ładowarka indukcyjna / wireless charger:	wejście / input: DC 9 V, 2 A / 12 V, 1,5 A / 5 V, 2 A, wyjście / output: 15 W

* LAYOUT – SZCZEGÓŁY NA STRONACH 116-117. / SPECIFICATION ON PAGES 116-117.



PUDEŁKO KOPERTOWE / ENVELOPE BOX



PUDEŁKO WIECZKOWE / BOX WITH A LID



PUDEŁKO ZASUWANE / SLIDING BOX

PUDEŁKA / BOXES

wymiar / size:

pod każdy format, z wyłączeniem kalendarza 504T i notesu A6 / for any format, except 504T calendar and A6 notebook

materiał / material:

papier barwiony w masie lub papier kraftowy / mass dyed paper or kraft paper*

metoda znakowania / marking method:

DTF, grawer / DTF, engraving





PUDEŁKO KOPERTOWE / ENVELOPE BOX



BANDEROLA / BANDEROLE



PUDEŁKO ZASUWANE NA ZESTAW / SLIDING BOX SET ^{NEW}

inspiracja / inspiration

wymiar / size:

materiał / material:

uszlachetnienie / refinement:

nakład / print run:

pod każdy format / for any format

papier / paper

folia 3D, lakier UV / 3D foil, UV varnish

min. 100 szt. / MOQ 100 pcs.



**SZLUFKA NA DŁUGOPIS /
PEN HOLDER**

szerokość / width:

10 mm



**GUMKA PIONOWA PŁASKA /
FLAT VERTICAL ELASTIC BAND**

szerokość / width:

10 mm



**SPOSÓB MONTOWANIA GUMKI NA TYLE OKŁADKI. /
TECHNIQUE OF ASSEMBLING THE ELASTIC BAND ON
THE BACK COVER.**



**GUMKA PIONOWA PŁASKA /
FLAT VERTICAL ELASTIC BAND**

szerokość / width:

10 mm

dodatek / add-on:

M23 – z naklejką epoksydową /
with epoxy sticker

GUMKA PŁASKA FLAT ELASTIC BAND 10 mm	TASIEMKA RIBBON 6 mm	KOLOR / COLOUR
		biały / white
		czarny / black
		szary / grey
		brązowy / brown
		ciemnograny / navy blue
		jasnograny / light navy blue
		niebieski / blue
		żółty / yellow
		zielony / green
		seledynowy / willow-green
		bordowy / maroon
		czerwony / red
		pomarańczowy / orange
		magenta / magenta
		beżowy / beige

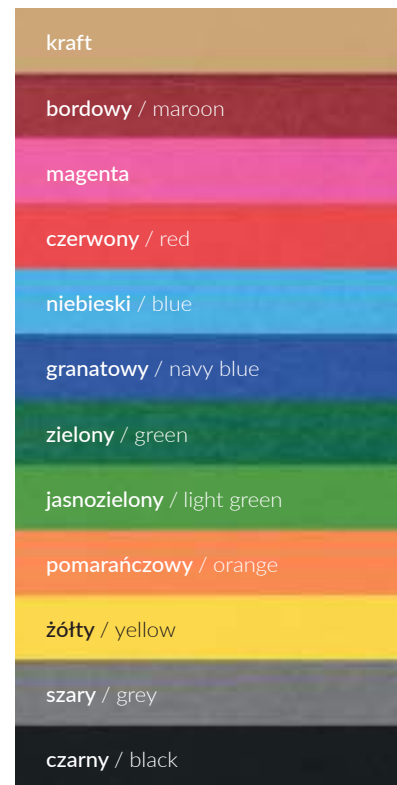

**PAPIER KRAFT I BARWIONY
W MASIE / KRAFT AND MASS
DYED PAPER**

zastosowanie / application:

koperta, wyklejka, wklejka,
opakowanie / envelope, endpaper,
insert page and packaging



**TASIEMKA SUBLIMACYJNA /
SUBLIMATION RIBBON**

wymiar / size:

8 mm, 10 mm

projekt / design:

autorski / customised

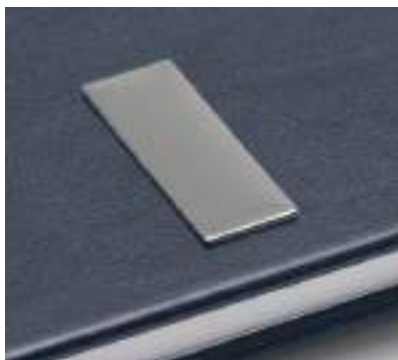

M1*
BLASZKA ALUMINIOWA /
ALUMINIUM PLATE

wymiar / size:

40 × 14 mm

pole graweru / engraving area:

38 × 12 mm

kolor / colour:

srebrny mat / silver matt

montaż / assembly:

klejenie do oprawy / stuck to cover



M3*
ROK FINOCHROMOWY /
FINOCHROME YEAR

wymiar / size:

41 × 8,5 mm

kolor / colour:

srebrny / silver

montaż / assembly:

klejenie do oprawy / stuck to cover



M4*
ROK FINOCHROMOWY /
FINOCHROME YEAR

wymiar / size:

10 × 10 mm

kolor / colour:

srebrny / silver

montaż / assembly:

klejenie do oprawy / stuck to cover



M2A* NEW
ROK ALUMINIOWY /
ALUMINIUM YEAR

wymiar / size:

24 × 24 mm

kolor / colour:

złoty / gold

montaż / assembly:

klejenie do oprawy / stuck to cover



M2B* NEW
ROK ALUMINIOWY /
ALUMINIUM YEAR

wymiar / size:

24 × 24 mm

kolor / colour:

srebrny / silver

montaż / assembly:

klejenie do oprawy / stuck to cover



M15
BLASZKA METALOWA /
METAL PLATE

wymiar / size:

45 × 14 mm

pole graweru / engraving area:

34 × 12 mm

kolor / colour:

srebrny mat / silver matt

montaż / assembly:

mocowanie na gumce 10 mm /
mounted on 10 mm elastic band

* MONTAŻ 10 mm OD BRZEGU OPRAWY. / MOUNTING 10 mm FROM THE EDGE OF COVER.



M16**
ZASUWKA METALOWA /
METAL HASP

wymiar / size:
30 × 15 mm

pole graweru / engraving area:
27 × 12 mm

kolor / colour:
czarny mat / black matt

montaż / assembly:

mocowanie na tylnej oprawie z kopertą /
mounted on the back cover with envelope



M17B*
KÓŁKO FINOCHROMOWE /
FINOCHROME DOT

wymiar / size:
ø5 mm

kolor / colour:
srebrny / silver

montaż / assembly:

klejenie do oprawy / stuck to cover



M17C*
KÓŁKO FINOCHROMOWE /
FINOCHROME DOT

wymiar / size:
ø5 mm

kolor / colour:
miedziany / copper

montaż / assembly:

klejenie do oprawy / stuck to cover



M18A*
OKRĄG FINOCHROMOWY /
FINOCHROME CIRCLE

wymiar / size:
ø23 mm

kolor / colour:
złoty / gold

montaż / assembly:

klejenie do oprawy / stuck to cover



M18B*
OKRĄG FINOCHROMOWY /
FINOCHROME CIRCLE

wymiar / size:
ø23 mm

kolor / colour:
srebrny / silver

montaż / assembly:

klejenie do oprawy / stuck to cover



M19*
OKRĄG FINOCHROMOWY /
FINOCHROME CIRCLE

wymiar / size:
ø16 mm

kolor / colour:
złoty / gold

montaż / assembly:

klejenie do oprawy / stuck to cover

* MONTAŻ 10 mm OD BRZEGU OPRAWY. / MOUNTING 10 mm FROM THE EDGE OF COVER.

** DOSTĘPNE W UKŁADZIE DZIENNYM I TYGODNIOWYM W KALENDARZACH I NOTESACH. / AVAILABLE FOR DAILY CALENDARS, WEEKLY CALENDARS AND NOTEBOOKS.

DODATKI / ADD-ONS



M20A*
LINIA FINOCHROMOWA /
FINOCHROME LINE

wymiar / size:

0,9 × 45 mm

kolor / colour:

złoty / gold

montaż / assembly:

klejenie do oprawy / stuck to cover



M20B*
LINIA FINOCHROMOWA /
FINOCHROME LINE

wymiar / size:

0,9 × 45 mm

kolor / colour:

srebrny / silver

montaż / assembly:

klejenie do oprawy / stuck to cover

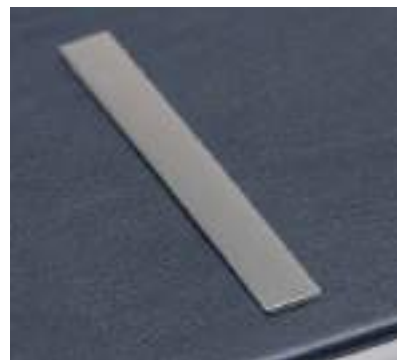

M21*
BLASZKA ALUMINIOWA
POD PERSONALIZACJĘ /
ALUMINIUM PLATE FOR
PERSONALISATION

wymiar / size:

8 × 70 mm

kolor / colour:

srebrny / silver

montaż / assembly:

klejenie do oprawy / stuck to cover



B2**
OKRĄG BAMBUSOWY POD DRUK /
BAMBOO CIRCLE WITH PRINT

wymiar / size:

ø30 mm

kolor / colour:

jasnobrązowy / light brown

montaż / assembly:

mocowanie w oprawie /
mounted on the cover



B4**
OWAL BAMBUSOWY POD DRUK /
BAMBOO OVAL WITH PRINT

wymiar / size:

14 × 40 mm

kolor / colour:

jasnobrązowy / light brown

montaż / assembly:

mocowanie w oprawie /
mounted on the cover



F1**
FORNIR / VENEER

wymiar / size:

9,5 × 86 mm

kolor / colour:

brązowy / brown

montaż / assembly:

mocowanie w oprawie /
mounted on the cover

* MONTAŻ 10 mm OD BRZEGU OPRAWY. / ASSEMBLY 10 mm FROM THE EDGE OF THE COVER.

** MONTAŻ TYLKO NA TEKSTURZE TWARDEJ, Z WYKLUCZENIEM KALENDARZA 504T. MONTAŻ 10 mm OD BRZEGU OPRAWY. /
MOUNTING ONLY ON HARD CARDBOARD, EXCEPT THE 504T CALENDAR. ASSEMBLY 10 mm FROM THE EDGE OF THE COVER.



**PERSONALIZACJA
GRAWEROWANA /
ENGRAVED PERSONALISATION**

font rekomendowany /
recommended font:

Verdana Regular min. 14 pkt /
min. 14 pt. Verdana Regular

projekt / design:

autorski / customised



**PATKA MAXI /
MAXI LEATHER TAB****

kolor / colour:

dowolny / any colour

montaż / assembly:

mocowanie na tylnej oprawie,
zamknięcie na magnes ukryty
w oprawie / mounted on the back
cover, with magnetic closure,
magnet hidden in cover

inne / other:

szlufka z miejscem na długopis /
pen holder



**TRÓJKĄTNA KIESZONKA Z FOLII /
TRIANGULAR FOIL POCKET**

wymiar / size:

80 × 80 mm
100 × 100 mm

kolor / colour:

transparentny / transparent

montaż / assembly:

klejenie do wyklejki /
sticked to endpaper



DRUK / PRINT



FOLIA / FOIL

**BARWIONE BRZEGI /
COLOURED EDGES***

wymiar / size:

pod każdy format / for any format

projekt / design:

autorski / customised

nakład / print run:

min. 100 szt. / MOQ 100 pcs.



**G0072
DŁUGOPIS METALOWY AUTOMATYCZNY Z ELEMENTEM KORKOWYM /
AUTOMATIC METAL PEN WITH CORK ELEMENT**

**G0073
DŁUGOPIS METALOWY AUTOMATYCZNY Z ELEMENTEM BAMBUSOWYM /
AUTOMATIC METAL PEN WITH BAMBOO ELEMENT**

wymiar / size:

144 × 10 mm

pole graweru / engraving area:

50 × 5 mm

inne / other:

pokrycie soft, końcówka dotykowa, wkład x-20 – 1 mm, kolor tuszu niebieski, długość
pisania około 1000 m / soft coating touch tip, x-20 – 1 mm refill, blue ink colour, writing
length approximately 1000 m

* MOŻLIWE BARWIENIE BRZEGÓW PRZEZ DRUK WEDŁUG CMYK BĄDŹ USZLACHTNIENIE FOLIA ZŁOTĄ LUB SREBRNĄ, Z WYKLUCZENIEM BLOKÓW Z PAPIERU Z KAMIENIA. / POSSIBLE COLOURING OF THE EDGES BY PRINTING IN CMYK OR FINISHING WITH GOLD OR SILVER FOIL, EXCLUDING STONE PAPER BOOK BLOCKS.

** Z WYKLUCZENIEM OPRAW PAPIEROWYCH, rPET, RE-COVER I FLEXI. / EXCLUDING PAPER, rPET, RE-COVER AND FLEXI COVERS.



M22

**ZAWIESZKA METALOWA
POD NAKLEJKĘ EPOKSYDOWĄ
LUB NAKLEJKĘ METALICZNA
Z FINOCHROMEM / METAL PLATE
WITH EPOXY OR FINOCHROME
METAL STICKER**

wymiar / size:

33 × 25 mm

pole znakowania / marking area:

∅21 mm

kolor / colour:

srebrny błysk / shiny silver

montaż / assembly:

mocowanie na gumce 10 mm /
mounted on 10 mm elastic band



M23

**ZAWIESZKA METALOWA
POD NAKLEJKĘ EPOKSYDOWĄ
LUB NAKLEJKĘ METALICZNA
Z FINOCHROMEM / METAL PLATE
WITH EPOXY OR FINOCHROME
METAL STICKER**

wymiar / size:

33 × 25 mm

pole znakowania / marking area:

22 × 22 mm

kolor / colour:

srebrny błysk / shiny silver

montaż / assembly:

mocowanie na gumce 10 mm /
mounted on 10 mm elastic band



M24

**ZAWIESZKA METALOWA
POD NAKLEJKĘ EPOKSYDOWĄ
LUB NAKLEJKĘ METALICZNA
Z FINOCHROMEM / METAL PLATE
WITH EPOXY OR FINOCHROME
METAL STICKER**

wymiar / size:

41 × 15 mm

pole znakowania / marking area:

30 × 12 mm

kolor / colour:

srebrny błysk / shiny silver

montaż / assembly:

mocowanie na gumce 10 mm /
mounted on 10 mm elastic band

**CHIP NFC - WGRAJ ODNOŚNIK DO SWOJEJ STRONY WWW! /
NFC CHIP - SHARE A LINK TO YOUR WEBSITE!**



Wgrane dane są odczytywane po zbliżeniu telefonu. Chip NFC może być wklejony na tekturze pod wyklejką, a informacja o nim umieszczona w formie naklejki lub nadruku na wyklejce. Once the data is uploaded, it can be accessed when phone is nearby. The NFC chip can easily adhere to the cardboard beneath the endpaper, the information can be shown as a sticker or printed directly onto endpaper.

NFC

wymiar / size:

∅30 mm

montaż / assembly:

wklejenie pod wyklejką /
sticked under the endpaper

WYCINANE REGISTRY / CUT-OUT INDEX

według specyfikacji bloków /
according to block specifications



NAKLEJKA METALICZNA / METALLIC STICKER

W DOWOLNYM KSZTAŁCIE, BAZA SZCZOTKOWANA LUB BŁYSZCZĄCA (ZŁOTO, SREBRO, MIEDŹ) Z NADRUKIEM UV CMYK / AVAILABLE IN ANY SHAPE, BRUSHED OR SHINY BASE (GOLD, SILVER, COPPER) WITH UV CMYK PRINTING



NAKLEJKA METALICZNA 3D / 3D METALLIC STICKER

W DOWOLNYM KSZTAŁCIE, BAZA SZCZOTKOWANA LUB BŁYSZCZĄCA (ZŁOTO, SREBRO, MIEDŹ) Z EFEKTEM WYPUKŁOŚCI W KOLORZE CMYK / AVAILABLE IN ANY SHAPE, BRUSHED OR SHINY BASE (GOLD, SILVER, COPPER) WITH BULGE EFFECT, CMYK PRINTING

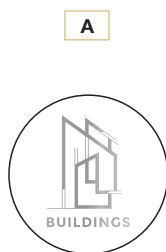

NAKLEJKI DO ZAWIESZEK METALOWYCH DOSTĘPNE SĄ W TRZECH WARIANTACH / STICKERS FOR METAL PLATE ARE AVAILABLE IN THREE VARIANTS:

A variant / variant

NAKLEJKA EPOKSYDOWA Z LOGO O PODŁOŻU CMYK ZE SREBRNYM FINOCHROMEM / CMYK BASED EPOXY STICKER WITH SILVER FINOCHROME

B variant / variant

NAKLEJKA METALICZNA / METALLIC STICKER

C variant / variant

NAKLEJKA METALICZNA 3D / 3D METALLIC STICKER



**WKLEJKA WYCINANA /
CUSTOMISED INSERT PAGE**

wymiar / size:

pod każdy format / for any format

materiał / material:

papier barwiony w masie /
mass dyed paper

papier kraftowy / kraft paper
kalka / tracing paper

metoda znakowania / marking method:

druk / printing

projekt / design:

autorski / customised



KALKA / TRACING PAPER

wymiar / size:

pod każdy format / for any format

metoda znakowania / marking method:

druk jednostronny / one-sided printing

zastosowanie / application:

obwoluta, wklejka / banderole, insert
page

projekt / design:

autorski / customised

ŁĄCZENIE OPRAW / COVER COMBINATIONS

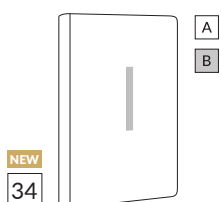
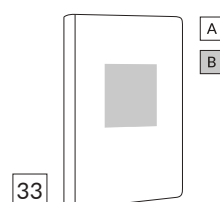
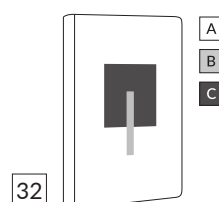
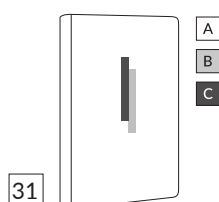
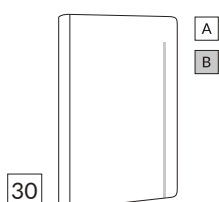
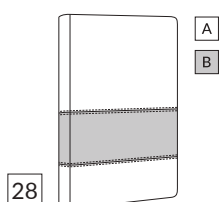
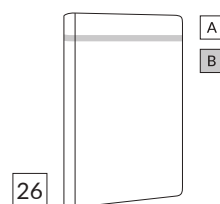
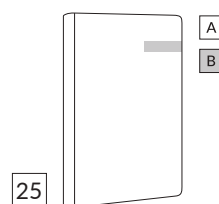
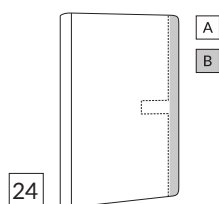
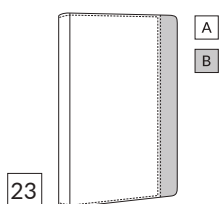
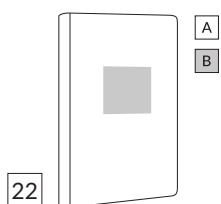
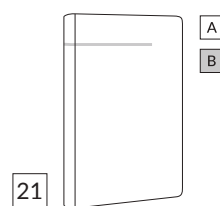
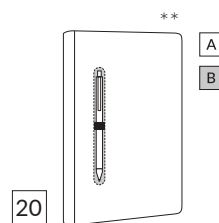
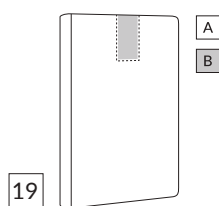
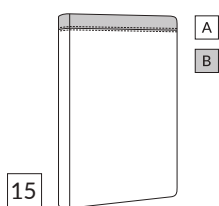
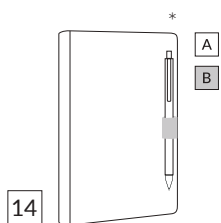
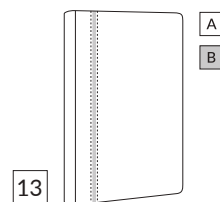
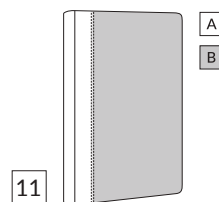
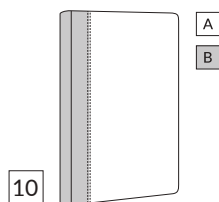
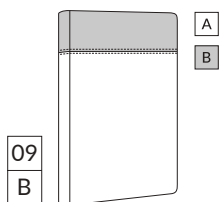
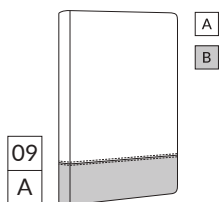
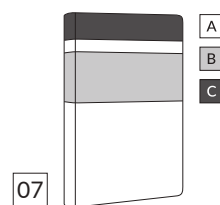
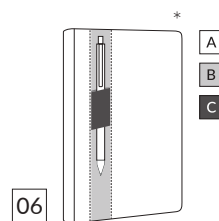
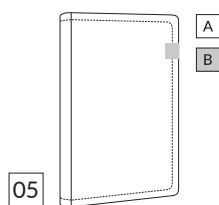
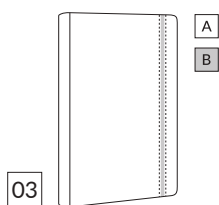
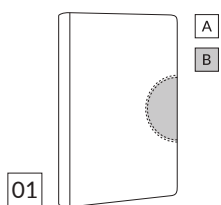

PRZEDSTAWIONA NUMERACJA JEST WYKAZEM DOSTĘPNYCH ŁĄCZEŃ OPRAW, Z WYKLUCZENIEM OPRAW PAPIEROWYCH I rPET.

THE NUMBERING SHOWN IS THE LIST OF COVER COMBINATIONS AVAILABLE, EXCLUDING PAPER AND rPET COVERS.

STWÓRZ SWÓJ WŁASNY PROJEKT!
CREATE YOUR OWN PROJECT!

CALENDARS.COM.PL/KREATOR

* SZLUFKA NA DŁUGOPIS Z EKOSKÓRY. / ELASTIC PEN HOLDER MADE OF ECO-LEATHER. ** SZLUFKA NA DŁUGOPIS Z GUMKI. / ELASTIC PEN HOLDER MADE OF ELASTIC BAND.



inspiracja / inspiration

rok / year design: **11**
 oprawa / cover: **VIVELA**
 metoda znakowania / marking method: **łtroczenie / debossing**
 dodatek / add-on: **gumka 10 mm / 10 mm elastic band**

inspiracja / inspiration

rok / year design: **7**
 oprawa / cover: **VIVELA**
 metoda znakowania / marking method: **łtroczenie / debossing**
 dodatek / add-on: **gumka 10 mm / 10 mm elastic band + M22 z naklejką metaliczną 3D / with 3D metallic sticker**



FLEXI
NOWE STANDARDY!
NEW STANDARDS!

inspiracja / inspiration

rok / year design: 5
oprawa / cover: VIVELA
metoda znakowania / tłoczenie / debossing
marking method:
dodatek / add-on: gumka 10 mm / 10 mm elastic band

inspiracja / inspiration

rok / year design: 6
oprawa / cover: VIVELA
metoda znakowania / tłoczenie / debossing
marking method:
dodatek / add-on: gumka 10 mm / 10 mm elastic band

TYPY OPRAW / TYPES OF COVER



OPRAWA NA TEKSTURZE TWARDEJ 2 mm BEZ BIGU LUB Z BIGIEM, ROGI OKŁADKI ZAOKRĄGLONE. / HARD COVER 2 mm WITH OR WITHOUT BEND, ROUNDED CORNERS OF THE COVER.



OPRAWA PAPIEROWA ZADRUKOWANA NA TEKSTURZE TWARDEJ 2 mm BEZ BIGU, ROGI OKŁADKI PROSTE LUB ZAOKRĄGLONE. / HARD PAPER COVER 2 mm, WITHOUT BEND, STRAIGHT OR ROUNDED CORNERS OF THE COVER.



OPRAWA NA TEKSTURZE Z PIANKĄ I BIGIEM, ROGI OKŁADKI ZAOKRĄGLONE. / HARD COVER WITH FOAM AND BEND, ROUNDED CORNERS OF THE COVER.



FLEXI* - KARTON ZAMIAST TEKSTURY, ROGI OKŁADKI ZAOKRĄGLONE, OBLIGATORYJNIE GUMKA NA OKŁADCE. / DIFFERENT TYPE OF CARDBOARD, ROUNDED CORNERS OF THE COVER, MANDATORY ELASTIC BAND.

* Z WYKLUCZENIEM OPRAW PAPIEROWYCH. / EXCLUDING PAPER COVERS.

PROJEKT AUTORSKI / CUSTOMISED DESIGN



WYKLEJKA / ENDPAPER



KOPERTA / ENVELOPE



WKLEJKA - KALKA / INSERT PAGE - TRACING PAPER



BLOK AUTORSKI / CUSTOMISED INTERIOR

PROPOZYCJE ROKÓW / YEAR DESIGN PROPOSITIONS

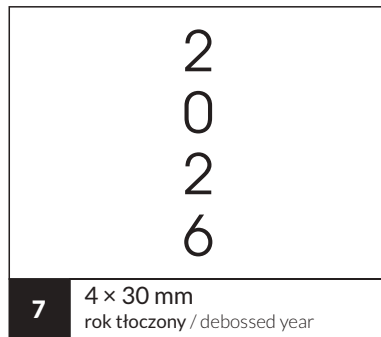
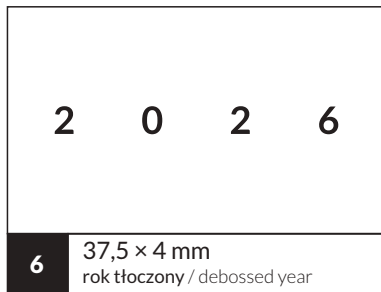
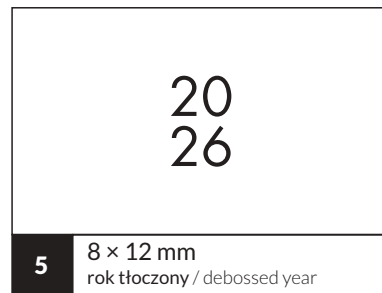

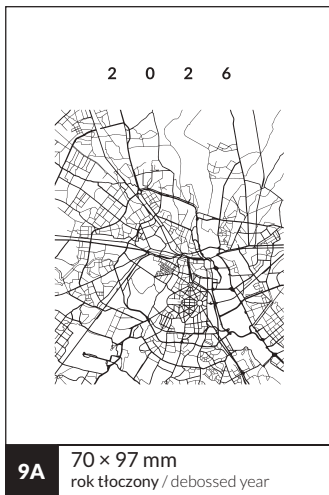

skala / scale 1:2

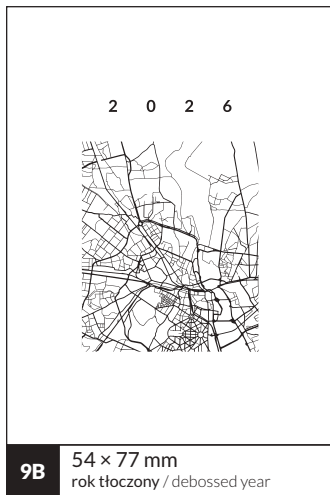

skala / scale 1:2

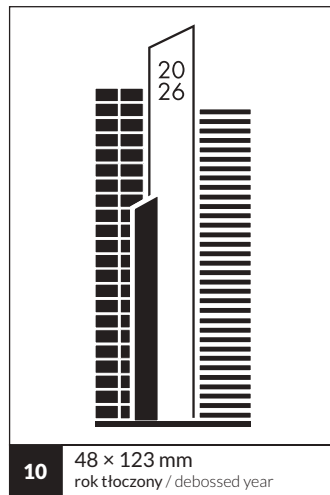

skala / scale 1:2

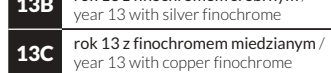
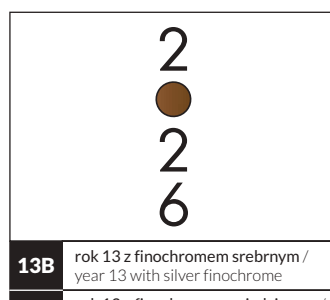
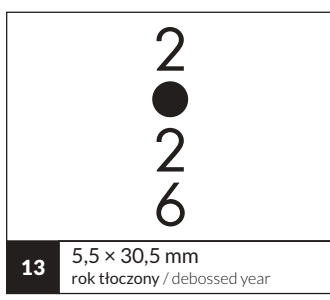
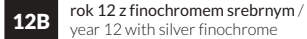
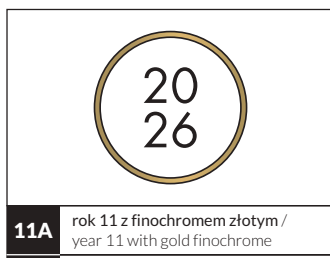
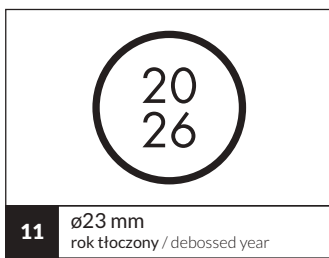

PROPOZYCJE ROKÓW / YEAR DESIGN PROPOSITIONS

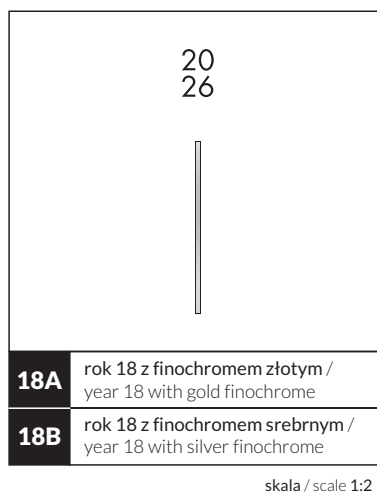
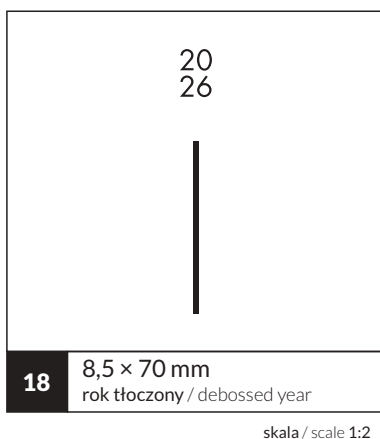
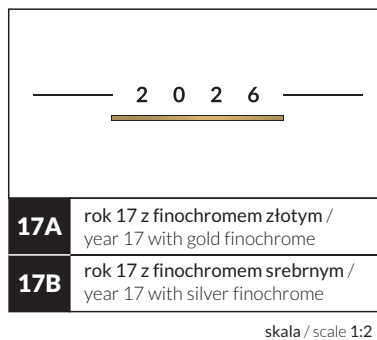
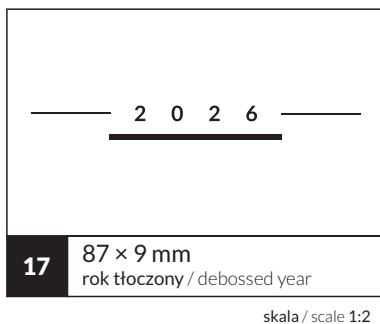
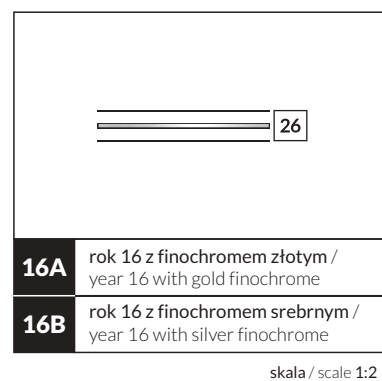
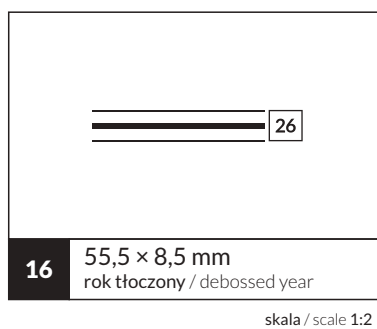
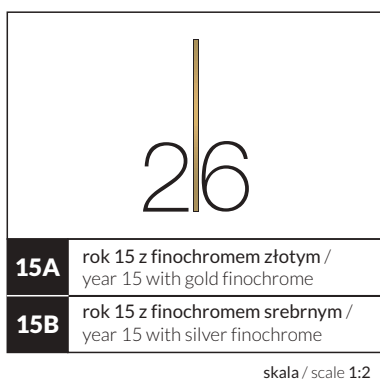
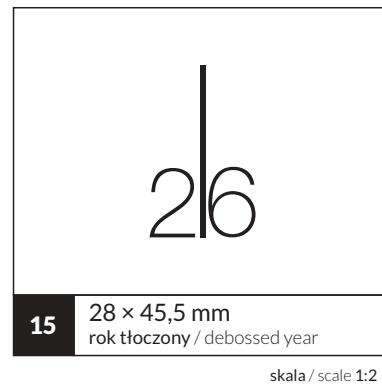
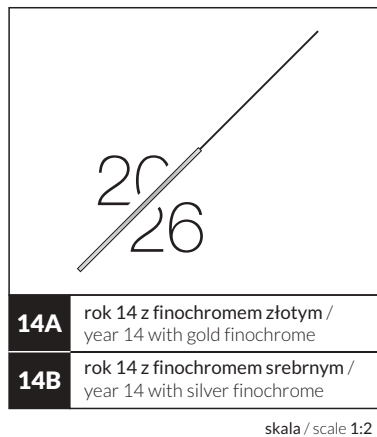
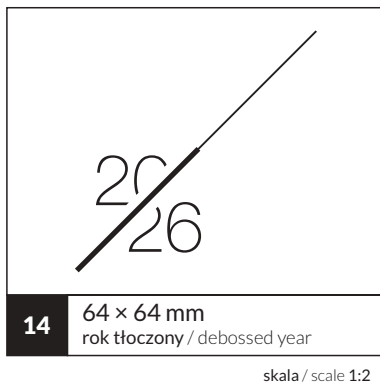

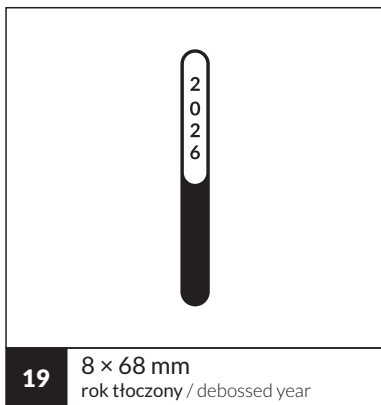

19 8 × 68 mm
rok tłoczony / debossed year

skala / scale 1:2

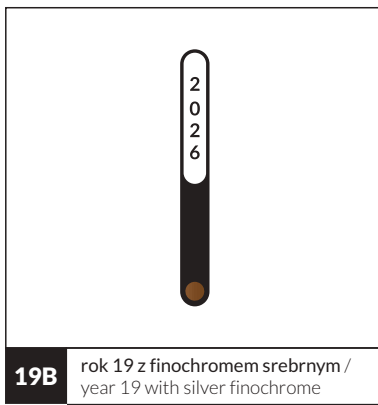

19B rok 19 z finochromem srebrnym /
year 19 with silver finochrome

19C rok 19 z finochromem miedzianym /
year 19 with copper finochrome

skala / scale 1:2

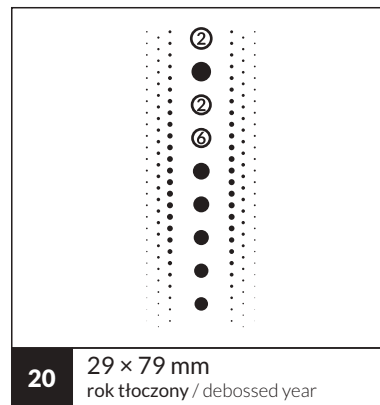

20 29 × 79 mm
rok tłoczony / debossed year

skala / scale 1:2

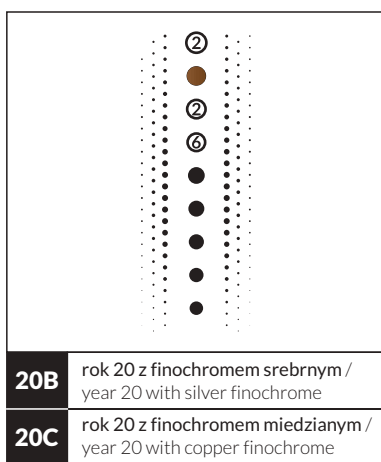

20B rok 20 z finochromem srebrnym /
year 20 with silver finochrome

20C rok 20 z finochromem miedzianym /
year 20 with copper finochrome

skala / scale 1:2

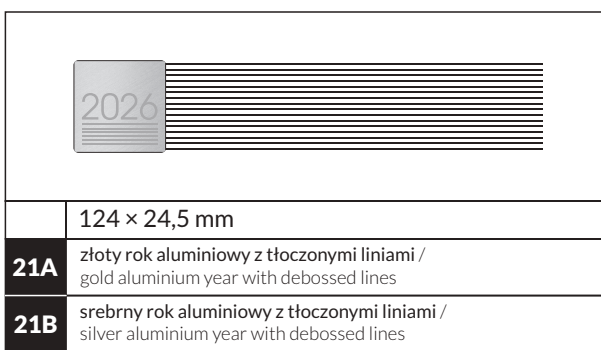

124 × 24,5 mm

21A złoty rok aluminiowy z tłoczonymi liniami /
gold aluminium year with debossed lines

21B srebrny rok aluminiowy z tłoczonymi liniami /
silver aluminium year with debossed lines

skala / scale 1:2



M2A 24 × 24 mm
złoty rok aluminiowy /
gold aluminium year



M2B 24 × 24 mm
srebrny rok aluminiowy /
silver aluminium year



M3 41 × 8,5 mm
rok finochromowy / finochrome year

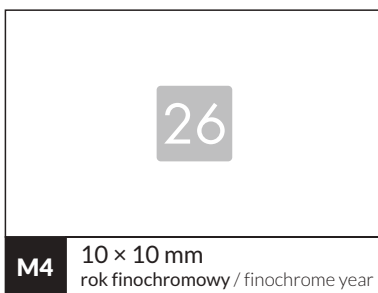

M4 10 × 10 mm
rok finochromowy / finochrome year

MATRYCE / STAMPS



1

81 × 82 mm
wzór tłoczony / debossed pattern

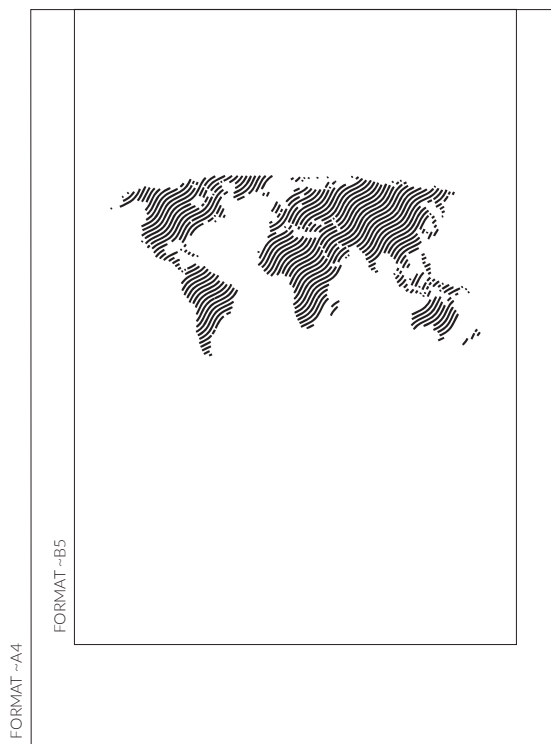

2

140 × 69 mm
wzór tłoczony / debossed pattern

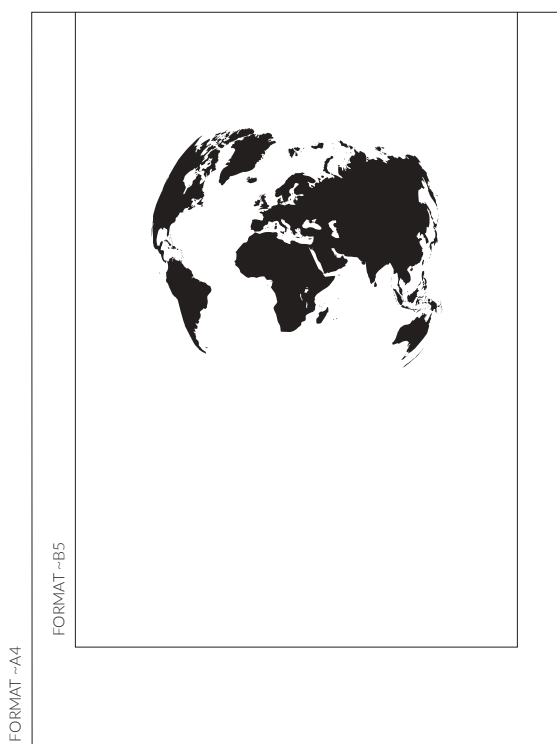

3

110 × 90 mm
wzór tłoczony / debossed pattern

DOSTĘPNA MATRYCA DOSTOSOWANA DO FORMATU -A5 /
STAMP TO -A5 FORMAT AVAILABLE - 65 × 79 mm

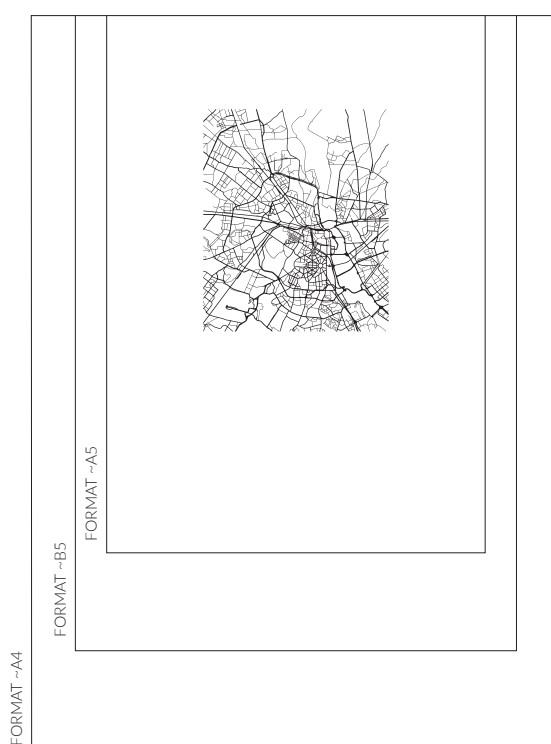

4

70 × 84 mm
wzór tłoczony / debossed pattern

DOSTĘPNA MNIEJSZA MATRYCA /
SMALL STAMP AVAILABLE - 54 × 65 mm

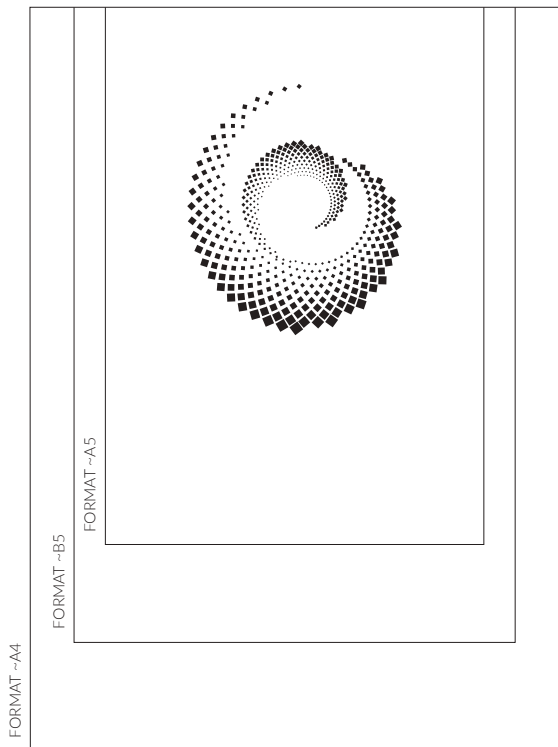

5 81 × 95 mm
wzór tłoczony / debossed pattern

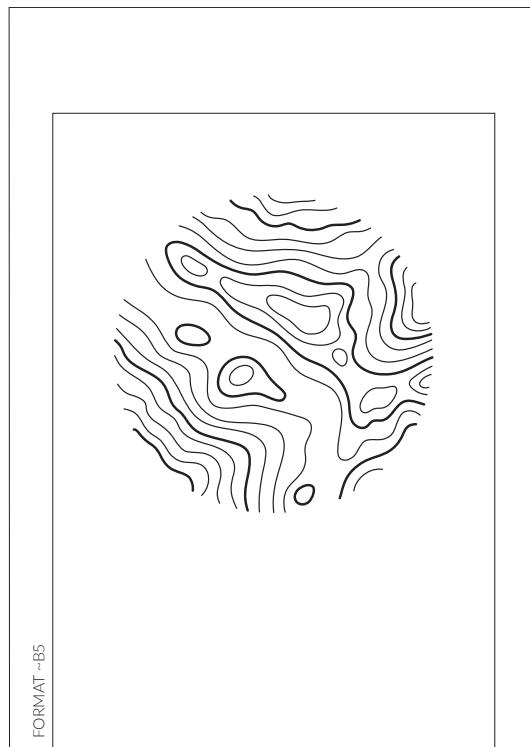

6 120 × 120 mm
wzór tłoczony / debossed pattern

DOSTĘPNA MATRYCA DOSTOSOWANA DO FORMATU -A5 /
STAMP TO -A5 FORMAT AVAILABLE - 94 × 94 mm

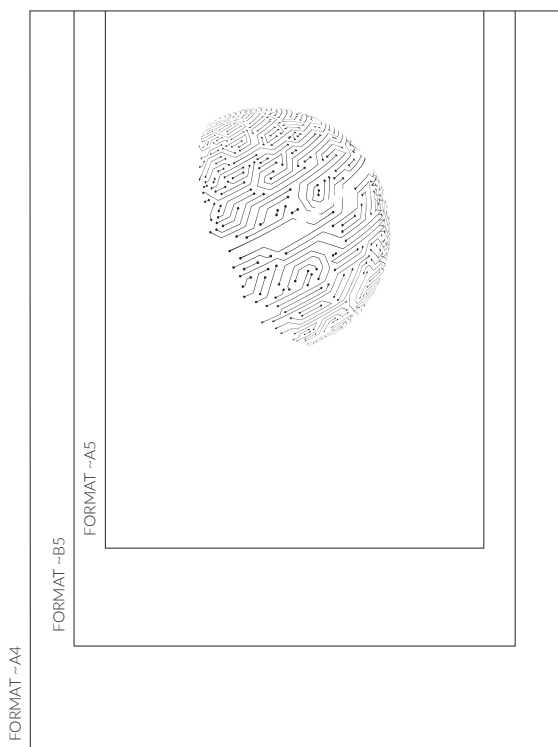

7 72 × 90 mm
wzór tłoczony / debossed pattern

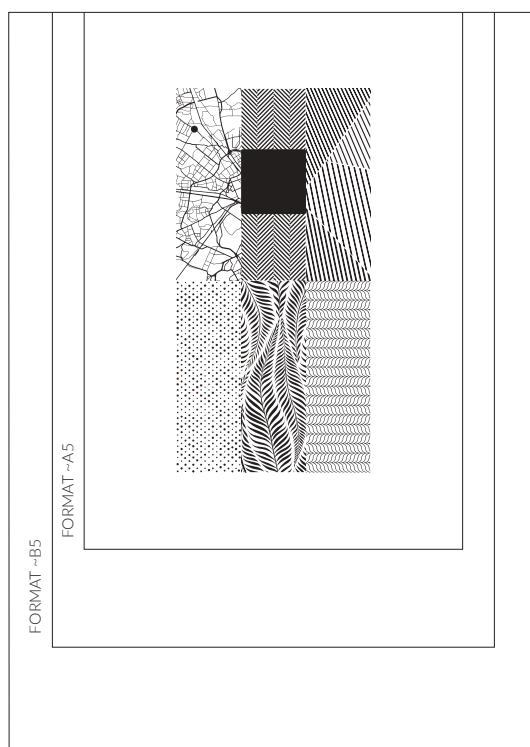

8 73 × 145 mm
wzór tłoczony / debossed pattern

MATRYCE / STAMPS

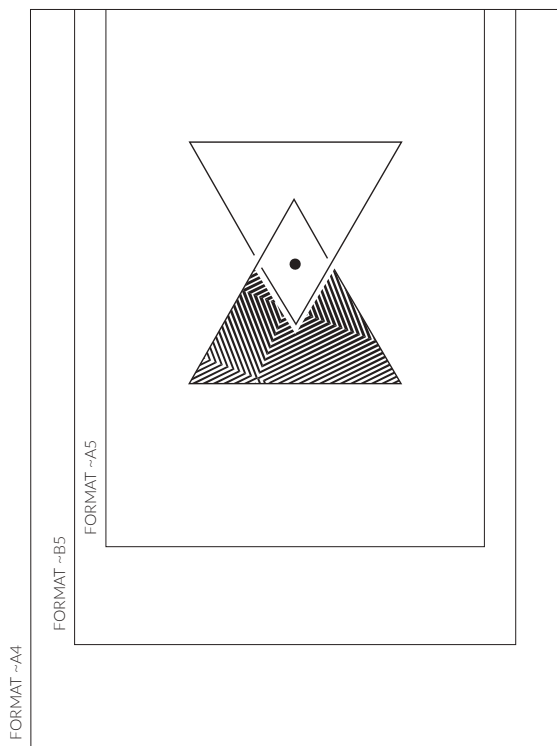

9

81 × 91 mm
wzór tłoczony / debossed pattern

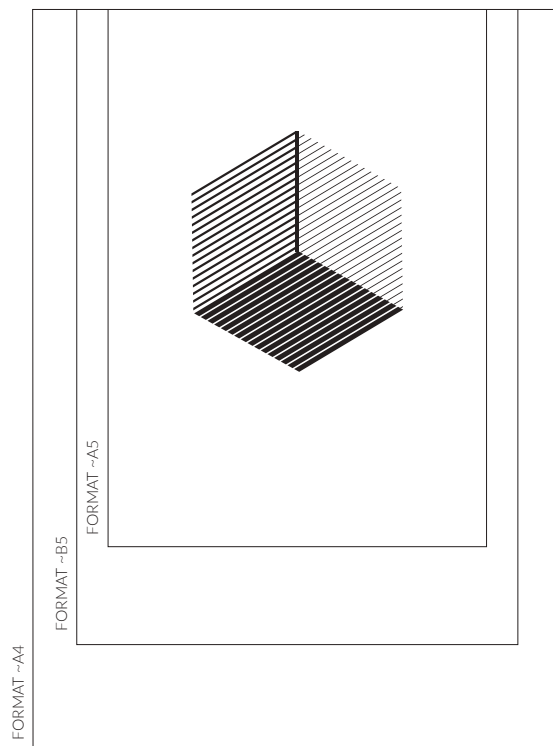

10

80 × 91 mm
wzór tłoczony / debossed pattern

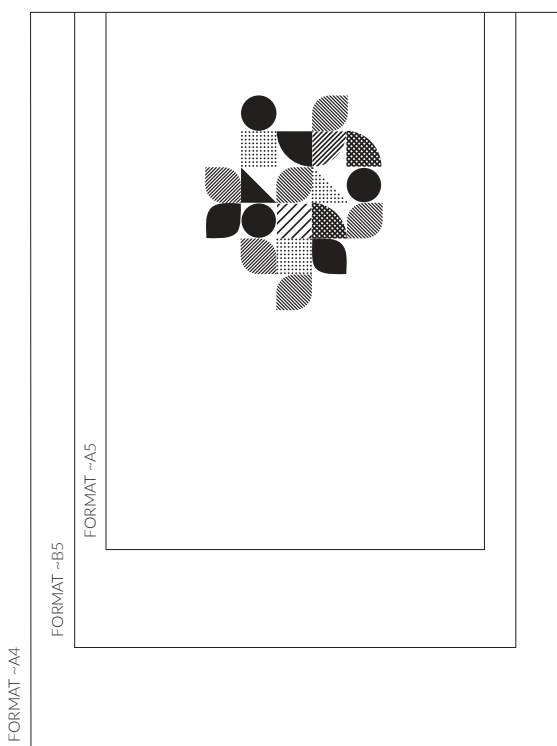

11

67 × 81 mm
wzór tłoczony / debossed pattern

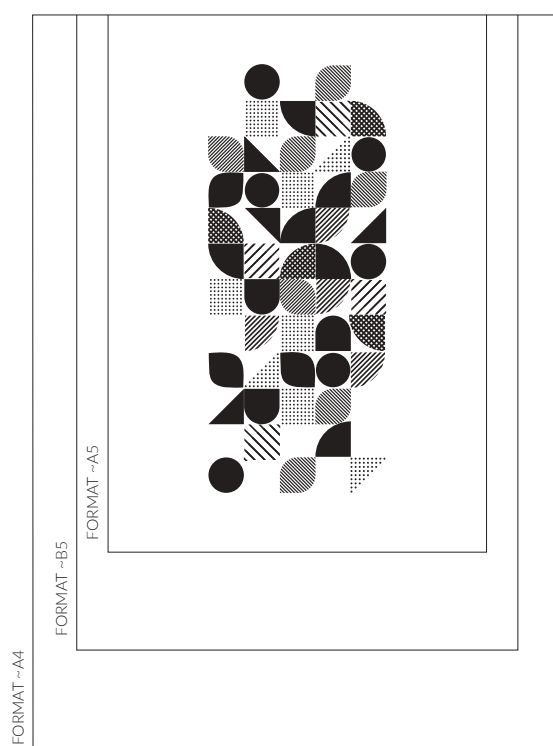

12

67 × 162 mm
wzór tłoczony / debossed pattern

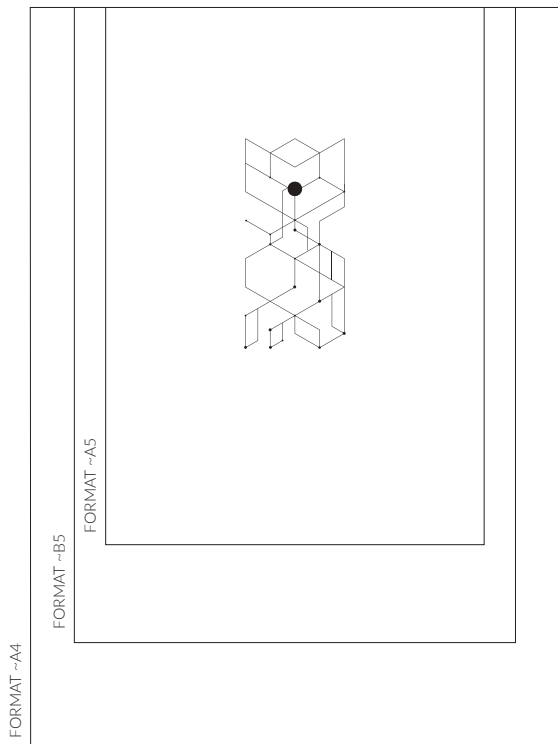

13

38 × 80 mm
wzór tłoczony / debossed pattern

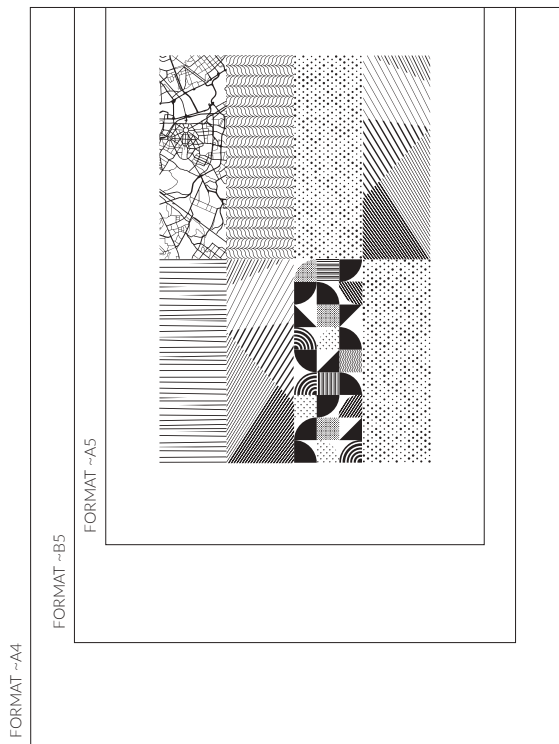

14

154 × 103 mm
wzór tłoczony / debossed pattern

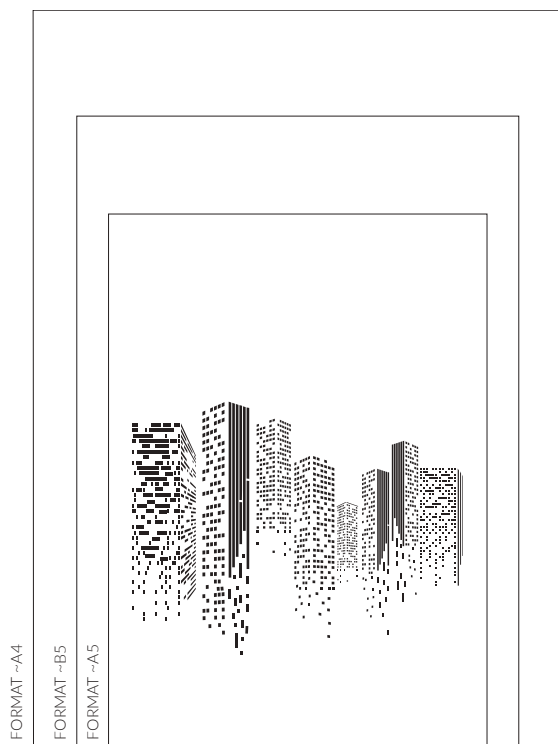

15

125 × 96 mm
wzór tłoczony / debossed pattern

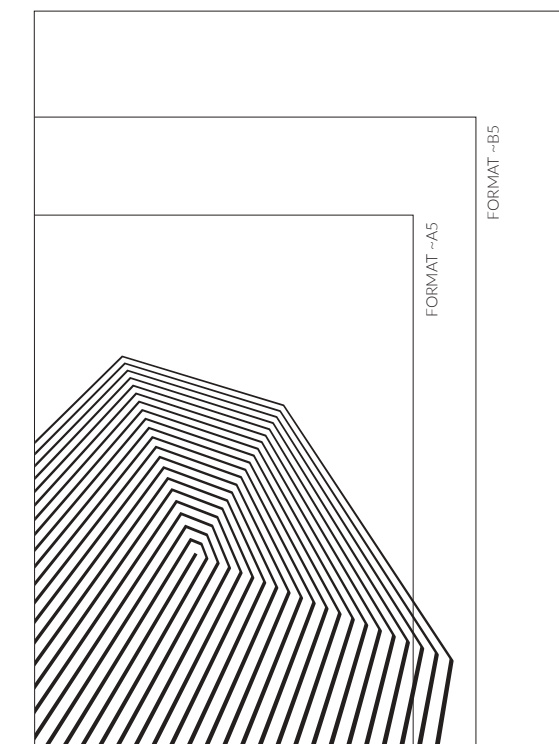

16

158 × 150 mm
wzór tłoczony / debossed pattern

PREZENTOWANE MATRYCE DO TŁOCZEŃ STANDARDOWYCH (MAX. 90 × 90 mm) I WIELKOFORMATOWYCH MOGĄ ZOSTAĆ UŻYTE BEZPŁATNIE DO DOWOLNEGO ZAMÓWIENIA. W TAKIM PRZYPADKU KLIENT PONOSI KOSZT WYŁĄCZNIE SAMEJ USŁUGI TŁOCZENIA ZGODNIE Z OBOWIĄZUJĄCYM CENNIKIEM (BEZ KOSZTÓW MATRYCY). PRESENTED STAMPS USED FOR THE STANDARD (MAX. 90 × 90 mm) AND LARGE FORMAT DEBOSSINGS CAN BE USED FREE OF CHARGE FOR ANY ORDER. IN THIS CASE, THE CUSTOMER PAYS ONLY FOR THE COST OF THE DEBOSSING SERVICE IN ACCORDANCE WITH THE APPLICABLE PRICE LIST (WITHOUT THE COSTS OF THE STAMP).

KALENDARZ / CALENDAR		501D	503D	508D	REGISTRY / INDEX		perforacja narożników corner perforation
format / format		200 × 280 mm ~A4	143 × 203 mm ~A5	162 × 240 mm ~B5	drukowane printed	wycinane cut-out	
liczba stron / pages		368	368	368			
papier biały / white paper druk / print	grafitowy graphite	✓	✓	✓	✓	✓	✓
papier chamois / ivory paper druk / print		✓	✓	✓	✓	✓	✓
papier z recyklingu / recycled paper druk / print			✓		✓		
papier z lnu / linen paper druk / print							
papier z kamienia / stone paper druk / print							
język / language		PL EN DE IT UK					
dane personalne / personal data		✓	✓	✓			
licznik dni / day counter		✓	✓	✓			
numeracja tygodni / week numbering		✓	✓	✓			
karta planowania celów / goal planning sheet		✓	✓	✓			
święta międzynarodowe / international holidays		✓	✓	✓			
kalendź skrócony / shortened calendar 2025-2027		✓	✓	✓			
plan urlopowy / vacation plan 2026		✓	✓	✓			
planer roczny / annual planner		✓	✓	✓			
planer miesięczny / monthly planner		✓	✓	✓			
kalendź roczny / annual calendar 2026		✓	✓	✓			
imieniny / name day		✓	✓	✓			
aforyzmy / aphorisms		✓	✓	✓			
oświadczenie drogowe / road accident statement		✓	✓	✓			
notes / notebook		✓	✓	✓			
mapy / maps							

KALENDARZ / CALENDAR		506D	REGISTRY / INDEX		perforacja narożników corner perforation
format / format		110 × 160 mm ~A6	drukowane printed	wycinane cut-out	
liczba stron / pages		368			
papier biały / white paper druk / print	grafitowy graphite	✓	✓		
papier chamois / ivory paper druk / print					
papier z recyklingu / recycled paper druk / print					
papier z lnu / linen paper druk / print					
papier z kamienia / stone paper druk / print					
język / language		PL EN DE IT UK			
dane personalne / personal data		✓			
licznik dni / day counter		✓			
numeracja tygodni / week numbering		✓			
karta planowania celów / goal planning sheet		✓			
święta międzynarodowe / international holidays		✓			
kalendarz skrócony / shortened calendar 2025-2027		✓			
plan urlopowy / vacation plan 2026		✓			
planer roczny / annual planner		✓			
planer miesięczny / monthly planner		✓			
kalendarz roczny / annual calendar 2026					
imieniny / name day		✓			
aforyzmy / aphorisms		✓			
oświadczenie drogowe / road accident statement					
notes / notebook		✓			
mapy / maps					

KALENDARZ / CALENDAR		510D	REGISTRY / INDEX		perforacja narożników corner perforation
format / format		143 × 203 mm ~A5	drukowane printed	wycinane cut-out	
liczba stron / pages		368			
papier biały / white paper druk / print	grafitowy graphite	✓	✓		
papier chamois / ivory paper druk / print					
papier z recyklingu / recycled paper druk / print					
papier z lnu / linen paper druk / print					
papier z kamienia / stone paper druk / print					
język / language		EN			
dane personalne / personal data		✓			
licznik dni / day counter		✓			
numeracja tygodni / week numbering		✓			
karta planowania celów / goal planning sheet		✓			
święta międzynarodowe / international holidays		✓			
kalendarz skrócony / shortened calendar 2025-2027		✓			
plan urlopowy / vacation plan 2026					
planer roczny / annual planner		✓			
planer miesięczny / monthly planner		✓			
kalendarz roczny / annual calendar 2026		✓			
imieniny / name day					
aforyzmy / aphorisms					
oświadczenie drogowe / road accident statement					
notes / notebook		✓			
mapy / maps					

UKŁADY KALENDARZY TYGODNIOWYCH / WEEKLY CALENDAR LAYOUTS

502T 507T

CZERWIEC

June, Juni, Giugno, *Eppere

1 152+213 Poniedziałek Mo / Mo / Lu / Hr	2 153+212 Wtorek Tu / Di / Ma / Br	3 154+211 Środa We / Mi / Me / Cp
--	--	---

DZIEŃ DZIECKA

Jakuba, Konrada	Erazma, Marianny	Leszka, Klotyldy
7		
8		
9		
10		
11		
12		
13		
14		
15		
16		
17		
18		

STYCZEŃ	LUTY	MARZEC	KWIECIEŃ	MAJ	CZERWIEC
T 1 2 3 4 5	5 6 7 8 9	9 10 11 12 13 14	14 15 16 17 18	18 19 20 21 22	23 24 25 26 27
PN 5 12 19 26	2 9 16 23	2 9 16 23 30	6 13 20 27	4 11 18 25	1 8 15 22 29
WT 6 13 20 27	3 10 17 24	3 10 17 24 31	7 14 21 28	5 12 19 26	2 9 16 23 30
ŚR 7 14 21 28	4 11 18 25	4 11 18 25	1 8 15 22 29	6 13 20 27	3 10 17 24
CZ 1 8 15 22 29	5 12 19 26	5 12 19 26	2 9 16 23 30	7 14 21 28	4 11 18 25
PI 2 9 16 23 30	6 13 20 27	6 13 20 27	3 10 17 24	1 8 15 22 29	5 12 19 26
SO 3 10 17 24 31	7 14 21 28	7 14 21 28	4 11 18 25	2 9 16 23 30	6 13 20 27
ND 4 11 18 25	1 8 15 22	1 8 15 22 29	5 12 19 26	3 10 17 24 31	7 14 21 28

TYDZIEŃ 23

Week, Woche, Settimana, Tvekdage

4 155+210 Czwartek Th / Do / Gi / Hr	5 156+209 Piątek Fr / Fr / Ve / Hr	6 157+208 Sobota Sa / Sa / Sa / C6
--	--	--

BOŻE CIAŁO

Karola, Franciszka	Walerii, Bonifacego	Pauliny, Norberta
7		
8		
9		
10		
11		
12		
13		
14		
15		
16		
17		
18		

LIPIEC	SIERPIEŃ	WRZESIEŃ	PAŹDZIERNIK	LISTOPAD	GRUDZIEŃ
T 27 28 29 30 31	31 32 33 34 35 36	36 37 38 39 40	40 41 42 43 44	44 45 46 47 48 49	49 50 51 52 53
PN 6 13 20 27	3 10 17 24 31	7 14 21 28	5 12 19 26	2 9 16 23 30	7 14 21 28
WT 7 14 21 28	4 11 18 25	1 8 15 22 29	6 13 20 27	3 10 17 24	1 8 15 22 29
ŚR 1 8 15 22 29	5 12 19 26	2 9 16 23 30	7 14 21 28	4 11 18 25	2 9 16 23 30
CZ 2 9 16 23 30	6 13 20 27	3 10 17 24	1 8 15 22 29	5 12 19 26	3 10 17 24 31
PI 3 10 17 24 31	7 14 21 28	4 11 18 25	2 9 16 23 30	6 13 20 27	4 11 18 25
SO 4 11 18 25	1 8 15 22 29	5 12 19 26	3 10 17 24 31	7 14 21 28	5 12 19 26
ND 5 12 19 26	2 9 16 23 30	6 13 20 27	4 11 18 25	1 8 15 22 29	6 13 20 27

Być bohaterem przez minutę, godzinę jest o wiele łatwiej niż znaleźć ludzi oddanych w odczynnych hesolom.
Fiodor Dostojewski

CZERWIEC



PLANER ROCZNY / ANNUAL PLANNER

KALENDARZ / CALENDAR		502T	507T	REGISTRY / INDEX		perforacja narożników corner perforation
format / format		208 × 260 mm ~A4	167 × 240 mm ~B5	drukowane printed	wycinane cut-out	
liczba stron / pages		160	160			
papier biały / white paper druk / print	grafitowy graphite	✓	✓	✓	✓	✓
papier chamois / ivory paper druk / print		✓	✓	✓	✓	✓
papier z recyklingu / recycled paper druk / print						
papier z lnu / linen paper druk / print			✓	✓		
papier z kamienia / stone paper druk / print						
język / language		PL EN DE IT UK				
dane personalne / personal data		✓	✓			
licznik dni / day counter		✓	✓			
numeracja tygodni / week numbering		✓	✓			
karta planowania celów / goal planning sheet		✓	✓			
święta międzynarodowe / international holidays		✓	✓			
kalendarz skrócony / shortened calendar 2025-2027		✓	✓			
plan urlopowy / vacation plan 2026		✓	✓			
planer roczny / annual planner		✓	✓			
planer miesięczny / monthly planner		✓	✓			
kalendarz roczny / annual calendar 2026		✓	✓			
imieniny / name day		✓	✓			
aforyzmy / aphorisms		✓	✓			
oświadczenie drogowe / road accident statement		✓	✓			
notes / notebook		✓	✓			
mapy / maps						

UKŁADY KALENDARZY TYGODNIOWYCH / WEEKLY CALENDAR LAYOUTS

504T

MARZEC		10
March, Márz, Marzo, Березень		
2	PONIEDZIAŁEK Mo / Mo / Lu / Пн	Helena, Halszki
3	WTOREK Tu / Di / Ma / Вт	Tycjana, Kunegundy
4	ŚRODA We / Mi / Me / Ср	Kazimierza, Łucji
5	CZWARTEK Th / Do / Gi / Чт	Fryderyka, Wacława
6	PIĄTEK Fr / Pi / We / Пт	Róży, Eugenii
7	SOBOTA Sa / So / Sa / Сб	Pawła, Tomasza
8	NIEDZIELA Su / So / Do / Нд	DZIEŃ KOBIET Beaty, Jana



ŚWIĘTA MIĘDZYNARODOWE / INTERNATIONAL HOLIDAYS

KALENDARZ / CALENDAR		504T	REGISTRY / INDEX		perforacja narożników corner perforation
format / format		84 × 151 mm format kieszonkowy pocket-sized format	drukowane printed	wycinane cut-out	
liczba stron / pages		128			
papier biały / white paper druk / print		grafitowy graphite	✓		
papier chamois / ivory paper druk / print			✓		
papier z recyklingu / recycled paper druk / print					
papier z lnu / linen paper druk / print					
papier z kamienia / stone paper druk / print					
język / language		PL EN DE IT UK			
dane personalne / personal data		✓			
licznik dni / day counter					
numeracja tygodni / week numbering		✓			
karta planowania celów / goal planning sheet					
święta międzynarodowe / international holidays		✓			
kalendarz skrócony / shortened calendar 2025-2027		✓			
plan urlopowy / vacation plan 2026					
planer roczny / annual planner					
planer miesięczny / monthly planner					
kalendarz roczny / annual calendar 2026					
imieniny / name day		✓			
aforyzmy / aphorisms					
oświadczenie drogowe / road accident statement					
notes / notebook		✓			
mapy / maps					

KALENDARZ / CALENDAR		509T	511T	512T	REGISTRY / INDEX		perforacja narożników corner perforation
format / format		149 × 203 mm ~A5	208 × 260 mm ~A4	167 × 240 mm ~B5	drukowane printed	wycinane cut-out	
liczba stron / pages		160	160	160			
papier biały / white paper druk / print	grafitowy graphite	✓	✓	✓			
papier chamois / ivory paper druk / print		✓		✓			
papier z recyklingu / recycled paper druk / print		✓		✓			
papier z lnu / linen paper druk / print		✓	✓	✓			
papier z kamienia / stone paper druk / print		✓	✓	✓			
język / language		PL EN DE IT UK					
dane personalne / personal data		✓	✓	✓			
licznik dni / day counter							
numeracja tygodni / week numbering		✓	✓	✓			
karta planowania celów / goal planning sheet		✓	✓	✓			
święta międzynarodowe / international holidays		✓	✓	✓			
kalendarz skrócony / shortened calendar 2025-2027		✓	✓	✓			
plan urlopowy / vacation plan 2026		✓	✓	✓			
planer roczny / annual planner		✓	✓	✓			
planer miesięczny / monthly planner		✓	✓	✓			
kalendarz roczny / annual calendar 2026							
imieniny / name day		✓	✓	✓			
aforyzmy / aphorisms		✓	✓	✓			
oświadczenie drogowe / road accident statement		✓	✓	✓			
notes / notebook		✓	✓	✓			
mapy / maps							

UKŁADY KALENDARZY TYGODNIOWYCH / WEEKLY CALENDAR LAYOUTS

514T - WERSJA MIĘDZYNARODOWA / INTERNATIONAL VERSION

SEPTEMBER	Week 38	
14 Monday		
15 Tuesday		
16 Wednesday		
17 Thursday		
18 Friday		
19 Saturday		20 Sunday

**MOŻLIWA MODYFIKACJA BLOKU NA DOWOLNY JĘZYK PRZY NAKŁADZIE MIN. 100 SZT.
POSSIBLE MODIFICATION OF THE BLOCK INTO ANY LANGUAGE WITH A MINIMUM PRINT RUN OF 100 PCS.**



KALENDARZ / CALENDAR		514T	REGISTRY / INDEX		perforacja narożników corner perforation
format / format		167 × 240 mm ~B5	drukowane printed	wycinane cut-out	
liczba stron / pages		160			
papier biały / white paper druk / print	grafitowy graphite	✓			
papier chamois / ivory paper druk / print					
papier z recyklingu / recycled paper druk / print					
papier z lnu / linen paper druk / print					
papier z kamienia / stone paper druk / print					
język / language		EN			
dane personalne / personal data		✓			
licznik dni / day counter					
numeracja tygodni / week numbering		✓			
karta planowania celów / goal planning sheet		✓			
święta międzynarodowe / international holidays		✓			
kalendarz skrócony / shortened calendar 2025-2027		✓			
plan urlopowy / vacation plan 2026					
planer roczny / annual planner		✓			
planer miesięczny / monthly planner		✓			
kalendarz roczny / annual calendar 2026					
imieniny / name day					
aforyzmy / aphorisms					
oświadczenie drogowe / road accident statement					
notes / notebook		✓			
mapy / maps					

PLANER / PLANNER		516	REGISTRY / INDEX		
format / format		167 × 240 mm ~B5	drukowane printed	wycinane cut-out	perforacja narożników corner perforation
liczba stron / pages		160			
papier biały / white paper druk / print	grafitowy graphite	✓			
papier chamois / ivory paper druk / print					
papier z recyklingu / recycled paper druk / print					
papier z lnu / linen paper druk / print					
papier z kamienia / stone paper druk / print		✓			
język / language		EN			
dane personalne / personal data		✓			
licznik dni / day counter					
numeracja tygodni / week numbering					
karta planowania celów / goal planning sheet					
święta międzynarodowe / international holidays					
kalendarz skrócony / shortened calendar 2025-2027					
plan urlopowy / vacation plan 2026					
planer roczny / annual planner		✓			
planer miesięczny / monthly planner					
kalendarz roczny / annual calendar 2026		✓			
imieniny / name day					
aforyzmy / aphorisms					
oświadczenie drogowe / road accident statement					
notes / notebook		✓			
mapy / maps					

KALENDARZ / CALENDAR		517	REGISTRY / INDEX		perforacja narożników corner perforation
format / format		147 × 203 mm ~A5	drukowane printed	wycinane cut-out	
liczba stron / pages		240			
papier biały / white paper druk / print	grafitowy graphite	✓			
papier chamois / ivory paper druk / print					
papier z recyklingu / recycled paper druk / print					
papier z lnu / linen paper druk / print					
papier z kamienia / stone paper druk / print					
język / language		PL EN			
dane personalne / personal data		✓			
licznik dni / day counter					
numeracja tygodni / week numbering		✓			
karta planowania celów / goal planning sheet					
święta międzynarodowe / international holidays		✓			
kalendarz skrócony / shortened calendar 2026		✓			
plan urlopowy / vacation plan 2026					
planer roczny / annual planner					
planer miesięczny / monthly planner		✓			
kalendarz roczny / annual calendar 2026					
imieniny / name day					
aforyzmy / aphorisms					
oświadczenie drogowe / road accident statement					
notes / notebook					
mapy / maps					

KALENDARZ / CALENDAR		505T	518T	G0085	REGISTRY / INDEX		perforacja narożników corner perforation
format / format		297 × 105 mm biurkowy desk	205 × 150 mm biurkowy desk	155 × 133 mm biurkowy desk	drukowane printed	wycinane cut-out	
liczba stron / pages		128	54	12			
papier biały / white paper druk / print	grafitowy graphite	✓	✓				
papier chamois / ivory paper druk / print							
papier z recyklingu / recycled paper druk / print							
papier z lnu / linen paper druk / print							
papier z kamienia / stone paper druk / print							
karton biały / white cardboard	czarno-zielony black-green lub / or czarno-brązowy black-brown			✓			
układ kalendarza tygodniowego / weekly calendar layout		✓	✓				
język / language		PL EN DE IT UK	PL EN	PL lub / or EN			
dane personalne / personal data		✓					
licznik dni / day counter		✓					
numeracja tygodni / week numbering		✓		✓			
karta planowania celów / goal planning sheet							
święta międzynarodowe / international holidays		✓					
kalendarz skrócony / shortened calendar 2025-2027		✓					
plan urlopowy / vacation plan 2026							
planer roczny / annual planner							
planer miesięczny / monthly planner						✓	
kalendarz roczny / annual calendar 2026			✓				
imieniny / name day		✓					
aforyzmy / aphorisms							
oświadczenie drogowe / road accident statement							
notes / notebook		✓					
mapy / maps							

UKŁADY NOTESOWE / NOTEBOOK LAYOUTS

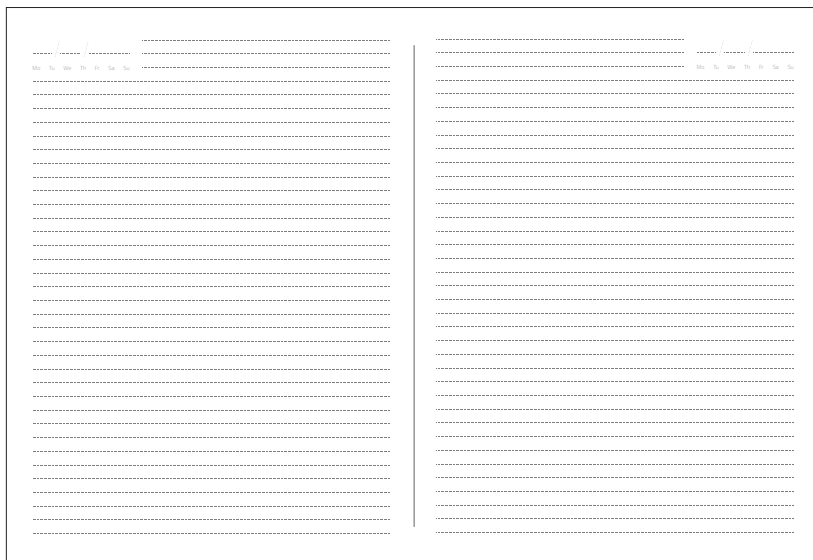

LINIA / LINE

WERSJA MIĘDZYNARODOWA / INTERNATIONAL VERSION

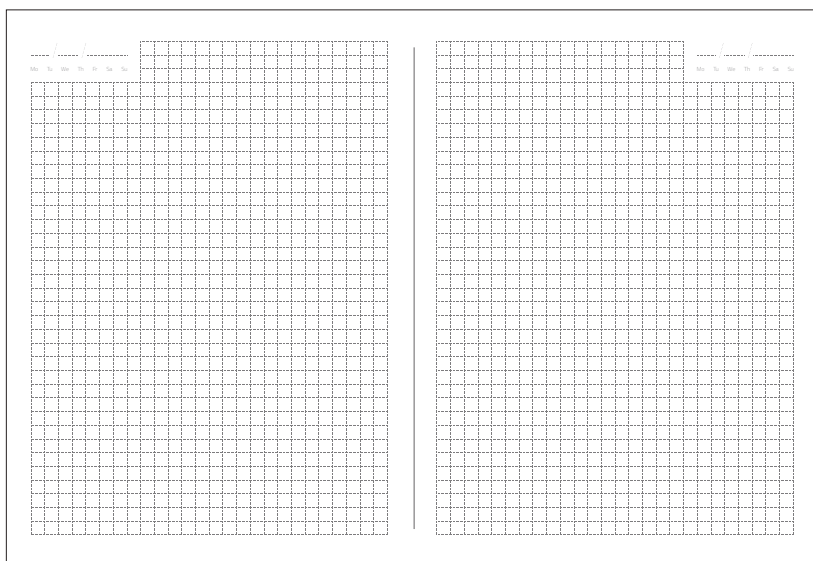

KRATKA / SQUARED

WERSJA MIĘDZYNARODOWA / INTERNATIONAL VERSION

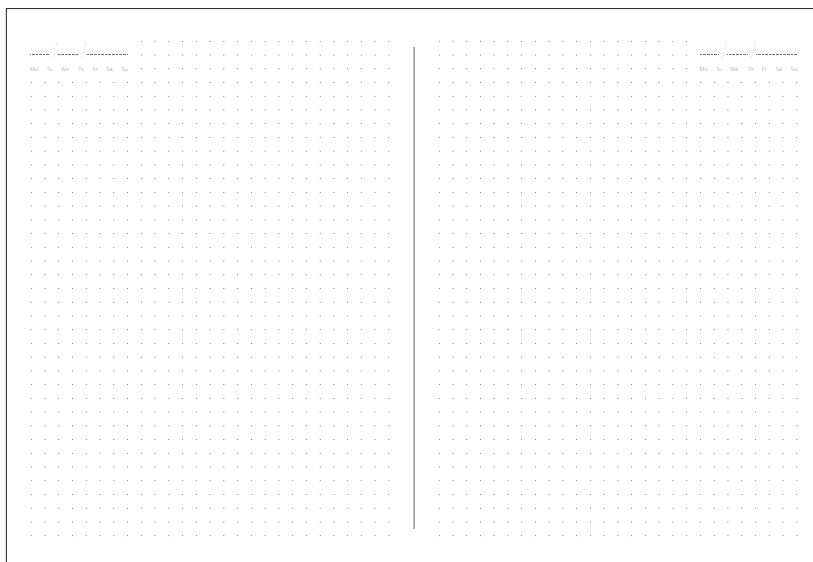

KROPKI / DOTS

WERSJA MIĘDZYNARODOWA / INTERNATIONAL VERSION

NOTES / NOTEBOOK			~A6	~A5	~B5	~A4
format / format			105 × 140 mm	130 × 208 mm	167 × 240 mm	208 × 260 mm
liczba stron / pages			192	192	192	192
papier biały / white paper druk / print	grafitowy graphite	linia line	✓	✓	✓	
		kratka squared	✓	✓	✓	✓
		kropki dots		✓		
		gładki plain	✓	✓		
papier chamois / ivory paper druk / print	grafitowy graphite	linia line		✓		
		kratka squared		✓		
		kropki dots				
		gładki plain				
liczba stron / pages				192	192	
papier z recyklingu / recycled paper druk / print	grafitowy graphite	linia line				
		kratka squared				
		kropki dots		✓	✓	
		gładki plain				
liczba stron / pages				144	144	
papier z trawy / grass paper druk / print	grafitowy graphite	linia line				
		kratka squared		✓	✓	
		kropki dots				
		gładki plain				
liczba stron / pages				144	144	
papier z lnu / linen paper druk / print	grafitowy graphite	linia line		✓	✓	
		kratka squared		✓	✓	
		kropki dots				
		gładki plain				
liczba stron / pages				144	144	
papier z kamienia / stone paper druk / print	grafitowy graphite	linia line		✓	✓	
		kratka squared		✓	✓	
		kropki dots		✓		
		gładki plain		✓		
język datownika / date header language			EN NIE DOTYCZY BŁOKÓW NOTESOWYCH GŁADKICH / does not apply to plain layout notebooks			



GADŻETY

G A D G E T S

SMYCZ WIELOFUNKCYJNA / MULTIFUNCTIONAL LANYARD



SMYCZ WIELOFUNKCYJNA / MULTIFUNCTIONAL LANYARD

numer katalogowy / catalogue number:

YS-201M

materiał / material:

poliester + ABS + metalowy karabińczyk pod identyfikator/kłucze / polyester + ABS + metal snap ring for ID/keys

wymiar / size:

~900 × 12 mm

metoda znakowania / marking method:

druk sublimacyjny – dwustronnie na smyczy / sublimation printing – on both sides of lanyard
druk UV – jednostronnie na łączniku / UV printing – one side on connector

specyfikacja / specification:

- kabel ładujący 6 w 1 / charging cable 6 in 1: wejście / input: USB-A, USB-C, wyjście / output: micro-USB, USB-C, Lightning (iPhone)
- transfer danych / data transfer
- natężenie / current: 2,4 A



SŁUCHAWKI DOUSZNE / EARPHONES

numer katalogowy / catalogue number:

G0084

materiał / material:

bambus + ABS / bamboo + ABS

wymiar / size:

~60 × 60 × 22 mm

metoda znakowania / marking method:

druk UV / UV printing

specyfikacja / specification:

- typ: bezprzewodowe / type: wireless
- Bluetooth: 5.0
- pojemność baterii w każdej słuchawce / battery capacity in each earphone: **30 mAh**
- pojemność baterii w etui / battery capacity in case: **230 mAh**
- czas pracy / working time: **3-4 godz.** / hour
- czas ładowania / charging time: **1-2 godz.** / hour
- złącza / connectors: wejście / input: **USB-C**



PODŚWIETLANA TARCZA / ILLUMINATED SURFACE

ROZGAŁĘŹNIK USB DŁUGI / LONG USB CHARGING CABLE

numer katalogowy / catalogue number:

G0082

materiał / material:

bambus + ABS / bamboo + ABS

wymiar / size:

~1250 × 35 × 10 mm

kolor / colour:

wstawka biała / white insert

światło / light:

00 – białe / white

metoda znakowania / marking method:

druk UV – jednostronnie / UV printing – one side

specyfikacja / specification:

- złącza / connectors:
wejście / input: **USB-A, USB-C**
wyjście / output: **USB-C, Lightning (iPhone)**



ADAPTER SIECIOWY / NETWORK ADAPTER

numer katalogowy / catalogue number:

G0083

materiał / material:

ABS

wymiar / size:

~75 × 30 × 30 mm

metoda znakowania / marking method:

druk UV / UV printing

specyfikacja / specification:

- złącza / connectors:
 - wejście / input: AC 110-240 V – 50/60 Hz – 0,5 A
 - wyjście / output: USB – QC 3.0 – 5 V – 3 A
 - USB-C – PD 20 W – 5 V – 3 A
- moc wyjściowa / output power: 20 W



ECO LID

zestaw / set:

rozgałęźnik USB długi / long USB charging cable **G0082**
słuchawki douszne / earphones **G0084**
adapter sieciowy / network adapter **G0083**

materiał opakowania / packaging material:

papier kraftowy / kraft paper

metoda znakowania opakowania /
marking method on the packaging:

grawer, tłoczenie, tłoczenie folią, DTF /
engraving, debossing, foil debossing, DTF



PODŚWIETLANE
LOGO /
ILLUMINATED
LOGO

ROZGAŁĘŻNIK USB KRÓTKI / SHORT USB CHARGING CABLE

numer katalogowy / catalogue number:

G0032

materiał / material:

bambus + ABS / bamboo + ABS

wymiar / size:

~160 × 35 × 10 mm

kolor / colour:

wstawka czarna / black insert

światło / light:

00 – białe / white

metoda znakowania / marking method:

grawer – jednostronnie / engraving – one side

specyfikacja / specification:

- złącza / connectors:
 - wejście / input: USB-A, USB-C
 - wyjście / output: micro-USB, USB-C, Lightning (iPhone)



PODŚWIETLANE
LOGO /
ILLUMINATED
LOGO

ROZGAŁĘŻNIK USB DŁUGI / LONG USB CHARGING CABLE

numer katalogowy / catalogue number:

G0031

materiał / material:

bambus + ABS / bamboo + ABS

wymiar / size:

~1200 × 35 × 10 mm

kolor / colour:

wstawka czarna / black insert

światło / light:

00 – białe / white

metoda znakowania / marking method:

grawer – jednostronnie / engraving – one side

specyfikacja / specification:

- złącza / connectors:
 - wejście / input: USB-A, USB-C
 - wyjście / output: USB-C, Lightning (iPhone)



ŁADOWARKA INDUKCYJNA / WIRELESS CHARGER

numer katalogowy / catalogue number:

G0015

materiał / material:

bambus / bamboo

wymiar / size:

~133 × 76 × 11 mm

metoda znakowania / marking method:

druk UV / UV printing

specyfikacja / specification:

- wejście / input: DV 5 V, 2 A
- wyjście / output: 5 W



ECO SET 9



ECO SET 10

ECO SET 9

zestaw / set:

notes A5, kalendarz 509T, 503D lub 510D /
A5 notebook, 509T, 503D or 510D calendar
rozgałęźnik USB długi / long USB charging cable **G0031**
długopis / pen **G0073**

ECO SET 10

zestaw / set:

notes A5, kalendarz 509T, 503D lub 510D /
A5 notebook, 509T, 503D or 510D calendar
długopis / pen **G0072**
kalendarz 504T / 504T calendar
lub / or
notes A6 / A6 notebook

materiał opakowania / packaging material:

papier kraftowy / kraft paper

metoda znakowania opakowania /
marking method on the packaging:

grawer, tłoczenie, tłoczenie folią, DTF /
engraving, debossing, foil debossing, DTF

ROZGAŁĘŹNIKI USB / USB CHARGING CABLES



ROZGAŁĘŹNIK USB KRÓTKI / SHORT USB CHARGING CABLE

numer katalogowy / catalogue number:

G0027, G0067, G0068, G0081

materiał / material:

ABS

wymiar / size:

~160 × 35 × 10 mm – G0027

~150 × 35 × 10 mm – G0067, G0068, G0081

kolor / colour:

czerwony / red – G0027

biały / white – G0067

czarny / black – G0068

granatowy / navy blue – G0081

światło / light:

00 – białe / white – G0027, G0067, G0068, G0081

02 – czerwone / red – G0067, G0068

07 – niebieskie / blue – G0067, G0068

03 – pomarańczowe / orange – G0067

metoda znakowania / marking method:

grawer – dwustronnie / engraving – on both sides – G0027, G0067, G0068, G0081

druk UV – dwustronnie / UV printing – on both sides – G0067

specyfikacja / specification – G0027:

- cztery porty zgodne z / four connectors compatible with: USB, micro-USB, USB-C, Lightning (iPhone)

specyfikacja / specification – G0067, G0068, G0081:

- złącza / connectors:
 - wejście / input: USB-A, USB-C
 - wyjście / output: micro-USB, USB-C, Lightning (iPhone)

GRAWER Z PODŚWIETLANYMI ELEMENTAMI POŁĄCZONY Z DRUKIEM UV / ILLUMINATED ENGRAVING COMBINED WITH HIGH-QUALITY UV PRINTING

DRUK UV / UV PRINTING



G0069

ROZGAŁĘŹNIK USB DŁUGI / LONG USB CHARGING CABLE

numer katalogowy / catalogue number:

G0069, G0070

materiał / material:

ABS

wymiar / size:

~1200 × 35 × 10 mm

kolor / colour:

biały / white – G0069

czarny / black – G0070

światło / light:

00 – białe / white

metoda znakowania / marking method:

grawer – jednostronnie / engraving – one side – G0069, G0070

druk UV – jednostronnie / UV printing – one side – G0069

specyfikacja / specification:

▪ złącza / connectors:

wejście / input: **USB-A, USB-C**

wyjście / output: **micro-USB, USB-C, Lightning (iPhone)**



G0070

PODŚWIETLANE LOGO / ILLUMINATED LOGO



**OPAKOWANIA STANDARD NA ROZGAŁĘŹNIKI USB /
STANDARD PACKAGING FOR USB CHARGING CABLES**

materiał / material:

folia / foil

metoda znakowania ulotki / leaflet marking method:

druk cyfrowy CMYK – dwustronnie /
CMYK digital printing – both sides

**TWOJA ULOTKA REKLAMOWA
W PEŁNYM KOLORZE**

**YOUR ADVERTISING LEAFLET
IN FULL COLOUR**



NEW

**ZASUWANE OPAKOWANIA AUTORSKIE NA ROZGAŁĘŻNIKI USB /
PERSONALISED SLIDING PACKAGING FOR USB CHARGING CABLES**

materiał / material:

wsuwka / pin – papier barwiony w masie / mass dyed paper

zasuwka / sliding – papier barwiony w masie lub karton / mass dyed paper or cardboard

metoda znakowania / marking method:

grawer, tłoczenie, tłoczenie folią, DTF – papier barwiony w masie / engraving, debossing, foil debossing, DTF – mass dyed paper
lub / or

folia 3D, lakier UV – karton / 3D foil, UV varnish – cardboard

POWERBANKI / POWERBANKS



PODŚWIETLANE LOGO / ILLUMINATED LOGO

POWERBANK / POWERBANK

numer katalogowy / catalogue number:

G0074

materiał / material:

ABS

wymiar / size:

~135 × 70 × 20 mm

kolor nakładki / colour of the flap:

01 – czarny / black

02 – czerwony / red

08 – granatowy / navy blue

00 – biały / white

światło / light:

00 – białe / white

02 – czerwone / red

07 – niebieskie / blue

metoda znakowania / marking method:

grawer – jednostronnie / engraving – one side

specyfikacja / specification:

- pojemność baterii / battery capacity: 10 000 mAh
- wyświetlacz cyfrowy: procent naładowania / digital display: charge level in percent
- żywotność: ok. 500 naładowań / battery lifespan: approx. 500 charge cycles
- wejście / input: micro-USB, USB-C – DC 5 V, 2 A
- wyjście / output: USB × 2 – DC 5 V, 2 A (max. 2,1 A)





G0077-01

POWERBANK / POWERBANK

numer katalogowy / catalogue number:

G0077-01

G0078-01

materiał / material:

aluminium

wymiar / size:

~145 × 65 × 15 mm - G0077-01

~145 × 65 × 20 mm - G0078-01

kolor / colour:

czarny / black

metoda znakowania / marking method:

grawer – jednostronnie / engraving – one side

specyfikacja / specification:

- wyświetlacz cyfrowy: procent naładowania / digital display: charge level in percent
- szybkie ładowanie / quick charge: 22,5 W
- wejście / input: USB-A, USB-C
- wyjście / output: USB-A, USB-C
- opakowanie: pudełko czarne / packaging: black box



G0078-01

POWER SET



MIKSUJ DOWOLNIE / MIX AS YOU WANT

POWER SET

zestaw / set:

powerbank + rozgałęźnik USB krótki /
powerbank + short USB charging cable

materiał opakowania / packaging material:

czarny papier barwiony w masie / black mass dyed paper

metoda znakowania opakowania /
marking method on the packaging:

grawer, tłoczenie, tłoczenie folią, DTF /
engraving, debossing, foil debossing, DTF



POWER SET LONG



POWER SET LONG

zestaw / set:

powerbank + rozgałęźnik USB długi /
powerbank + long USB charging cable

materiał opakowania / packaging material:

czarny papier barwiony w masie / black mass dyed paper

metoda znakowania opakowania /
marking method on the packaging:

grawer, tłoczenie, tłoczenie folią, DTF /
engraving, debossing, foil debossing, DTF

ENERGY SET



ENERGY SET

zestaw / set:

kalendarz/notes + powerbank + rozgałęźnik USB krótki / calendar/notebook + powerbank + short USB charging cable

kalendarz lub notes / calendar or notebook:

503D, 509T, 510D – kalendarz / calendar lub / or A5 – notes / notebook

materiał opakowania / packaging material:

czarny papier barwiony w masie / black mass dyed paper

metoda znakowania opakowania / marking method on the packaging:

grawer, tłoczenie, tłoczenie folią, DTF / engraving, debossing, foil debossing, DTF

MIKSUJ DOWOLNIE Z WYBRANYM KALENDARZEM/NOTESEM Z KOLEKCJI 2026
MIX AS YOU WANT WITH YOUR CHOSEN CALENDAR/NOTEBOOK FROM THE 2026 COLLECTION

WHITE BOX & BLACK BOX



WHITE BOX & BLACK BOX

zestaw / set:

kalendarz/notes + rozgałęźnik USB krótki lub długi /
calendar/notebook + short or long USB charging cable

kalendarz lub notes / calendar or notebook:

pod każdy format, z wyłączeniem kalendarza 501D i 505T /
for any format, except 501D and 505T calendars

materiał opakowania / packaging material:

czarny papier barwiony w masie / black mass dyed paper
lub / or
biały karton / white cardboard

metoda znakowania opakowania /
marking method on the packaging:

grawer, tłoczenie, tłoczenie folią, DTF /
engraving, debossing, foil debossing, DTF

ZESTAWIENIE BLOKÓW / OVERVIEW OF INTERIOR BLOCKS

KALENDARZ DZIENNY / DAILY CALENDAR

BLOK BLOCK	LICZBA STRON PAGES	FORMAT FORMAT	PAPIER / PAPER				PLANER MIESIĘCZNY MONTHLY PLANNER	PERFORACJA NAROŻNA CORNER PERFORATION	AFORYZMY APHORISMS	REGISTRY / INDEX	
			BIAŁY WHITE	CHAMOIS IVORY	RECYKLING RECYCLED	DRUK PRINT*				WYCINANE CUT-OUT	DRUKOWANE PRINTED
501D	368	200 × 280 mm	✓	✓		●	✓	✓	✓	✓	✓
503D	368	143 × 203 mm	✓	✓		●	✓	✓	✓	✓	✓
					✓	●	✓		✓		✓
506D	368	110 × 160 mm	✓			●	✓		✓		✓
508D	368	162 × 240 mm	✓	✓		●	✓	✓	✓	✓	✓
510D	368	143 × 203 mm	✓			●	✓				✓

* ● kolor druku / print colour

KALENDARZ TYGODNIOWY / WEEKLY CALENDAR

BLOK BLOCK	LICZBA STRON PAGES	FORMAT FORMAT	PAPIER / PAPER						PLANER MIESIĘCZNY MONTHLY PLANNER	PERFORACJA NAROŻNA CORNER PERFORATION	AFORYZMY APHORISMS	REGISTRY / INDEX	
			BIAŁY WHITE	CHAMOIS IVORY	RECYKLING RECYCLED	LEN LINEN	KAMIEŃ STONE	DRUK PRINT*				WYCINANE CUT-OUT	DRUKOWANE PRINTED
502T	160	208 × 260 mm	✓	✓				●	✓	✓	✓	✓	✓
504T	128	84 × 151 mm	✓	✓				●					
505T	128	297 × 105 mm	✓					●					
507T	160	167 × 240 mm	✓	✓				●	✓	✓	✓	✓	✓
						✓		●	✓		✓		✓
509T	160	149 × 203 mm	✓	✓	✓	✓	✓	●	✓		✓		
511T	160	208 × 260 mm	✓				✓	●	✓		✓		
512T	160	167 × 240 mm	✓	✓	✓	✓	✓	●	✓		✓		
514T	160	167 × 240 mm	✓					●	✓				
518T	54	205 × 150 mm	✓					●					

* ● kolor druku / print colour

PLANER DZIENNY Z NOTESEM / DAILY PLANNER WITH NOTEBOOK

BLOK BLOCK	LICZBA STRON PAGES	FORMAT FORMAT	PAPIER / PAPER		
			BIAŁY WHITE	KAMIEŃ STONE	DRUK PRINT*
516	160	167 × 240 mm	✓	✓	●

* ● kolor druku / print colour

KALENDARZ DWUDZIENNY / TWO-DAY CALENDAR

BLOK BLOCK	LICZBA STRON PAGES	FORMAT FORMAT	PAPIER / PAPER	
			BIAŁY WHITE	DRUK PRINT*
517	240	147 × 203 mm	✓	●

* ● kolor druku / print colour

KALENDARZ MIESIĘCZNY / MONTHLY CALENDAR

BLOK BLOCK	LICZBA STRON PAGES	FORMAT FORMAT	PAPIER / PAPER	
			KARTON CARDBOARD	DRUK PRINT*
G0085	12	155 × 133 mm	✓	●● / ●●

* PL ●●, EN ●● kolor druku / print colour

NOTES / NOTEBOOK

BLOK BLOCK	LICZBA STRON PAGES	FORMAT FORMAT	PAPIER / PAPER						GŁADKI PLAIN	LINIA LINE	KRATKA SQUARED	KROPKI DOTS
			BIAŁY WHITE	CHAMOIS IVORY	RECYKLING RECYCLED	TRAWA GRASS	LEN LINEN	KAMIEŃ STONE				
A6	192	105 × 140 mm	✓						●	✓	✓	✓
A5	192	130 × 208 mm	✓						●	✓	✓	✓
				✓				●		✓	✓	✓
	144	130 × 208 mm			✓			●			✓	
						✓		●		✓	✓	✓
B5	192	167 × 240 mm	✓					●	✓	✓	✓	
					✓			●		✓	✓	✓
	144	167 × 240 mm					✓	●		✓	✓	
A4	192	208 × 260 mm	✓					●			✓	

* ● kolor druku / print colour

Ze względu na ograniczenia wynikające z techniki druku rzeczywiste kolory poszczególnych towarów mogą nieznacznie różnić się od kolorów prezentowanych na zdjęciach. Podane wymiary są wymiarami orientacyjnymi i nie mogą stanowić podstawy reklamacji. Producent zastrzega sobie prawo do technicznych zmian poszczególnych produktów, a także nie ponosi odpowiedzialności za ewentualne błędy w druku. Wszystkie znaki firmowe zamieszczone w katalogu są własnością ich autorów i zaprezentowane są jedynie w celach poglądowych. Katalog nie stanowi oferty w myśl przepisów kodeksu cywilnego. Produkcja w Polsce. / Due to restrictions of printing techniques, actual colours may slightly vary from the ones presented in the catalogue. The sizes and formats provided are for reference only and cannot be the subject of complaint. The manufacturer reserves the right to technical modifications, and is not responsible for any possible printing errors. All the trademarks that appear in the catalogue are the property of their authors and are presented for reference only. The catalogue does not constitute an offer within the meaning of the civil code. Made in Poland.